

I.O.S.

RRS FREDERICK RUSSELL
CRUISE 9/86
11 OCTOBER – 21 NOVEMBER 1986

– HEXOS –
HUMIDITY EXCHANGE OVER THE SEA EXPERIMENT

CRUISE REPORT NO. 190
1987

NATURAL ENVIRONMENT
INSTITUTE OF
OCEANOGRAPHIC
SCIENCES
RESEARCH
COUNCIL

INSTITUTE OF OCEANOGRAPHIC SCIENCES

Wormley, Godalming, Surrey, GU8 5UB.

(042 - 879 - 4141)

(Director: Dr A.S. Laughton FRS)

Bidston Observatory,

Birkenhead, Merseyside, L43 7RA.

(051 - 653 - 8633)

When citing this document in a bibliography the reference should be given as follows:-

TAYLOR, P.K. *et al* 1987 RRS *Frederick Russell*
Cruise 9/86, 11 October - 21 November 1986.
HEXOS - Humidity Exchange Over the Sea Experiment.
Institute of Oceanographic Sciences, Cruise Report,
No. 190, 55pp.

INSTITUTE OF OCEANOGRAPHIC SCIENCES

WORMLEY

RRS FREDERICK RUSSELL

Cruise 9/86

11 October - 21 November 1986

- HEXOS -

Humidity Exchange over the Sea Experiment

Principal Scientist

P.K. Taylor

CRUISE REPORT NO. 190

March 1987

CONTENTS	Page
PERSONNEL	5
INTRODUCTION	7
NARRATIVE	8
METEOROLOGICAL CONDITIONS	11
SCIENTIFIC PROGRAMME REPORTS	12
1. WMO OBSERVATIONS	12
2. RAIN GAUGE	14
3. IOS METEOROLOGICAL MEASUREMENTS - Multimet System A	14
3.1 Introduction	14
3.2 Sensor Deployment	15
3.3 Wind Speed and Direction	16
3.4 Aspirated Psychrometers	16
3.5 Humidity Sensors	17
3.6 Sea Surface Temperature	17
3.7 Radiation Sensors	18
3.8 Ship's Head	18
3.9 Precipitation Detector	19
3.10 Electromagnetic Log	19
3.11 Metman Software	20
4. IOS INERTIAL DISSIPATION SYSTEM	20
5. NPS TURBULENT FLUX MEASUREMENTS	21
5.1 Introduction	21
5.2 Data Processing and Analysis	22
5.3 Hot Film Anemometers	23
5.4 Lyman Alpha Humidiometer	23
5.5 Mini-cup Anemometers	24

	Page
6. UMIST AEROSOL AND HUMIDITY MEASUREMENTS	25
6.1 Introduction	25
6.2 Aerosol Probes	25
6.3 Dewpoint Sensors	26
6.4 Wind and Temperature Sensors	27
6.5 Ship Sensors	27
6.6 Logging System	27
7. RADIOSONDE ASCENTS	28
8. SST RADIOMETER	29
9. SEA SURFACE TEMPERATURE AND SALINITY MAPPING	30
10. WAVE MEASUREMENTS	30
11. DECCA NAVIGATOR SYSTEM	31
12. IOS SHIPBOARD COMPUTING	32
FIGURES	34
APPENDIX 1.	39
HEXOS Activity Summary Sheets for the <u>Frederick Russell</u>	
APPENDIX 2.	54
List of Radiosonde ascents.	

SCIENTIFIC PERSONNEL

			Legs:	1	2	3	4
Taylor, Peter K	(IOS)	PSO		x	x	x	x
Birch, Keith G.	(IOS)	Applied Physics		x	x		x
Fellbaum, Sheryl	(NPS)	Environmental Physics Group			x	x	
Guymer, Trevor H.	(IOS)	Marine Physics		x	x	x	x
Hill, Martin K.	(UMIST)	Atmos. Physics		x	x	x	x
Park, Pauline	(UMIST)	Atmos. Physics			x	x	x
Pascal, Robin W.	(IOS)	Applied Physics		x	x	x	x
Perrett, James R.	(IOS)	Applied Physics				x	
Skupniewicz, Chuck	(NPS)	Environmental Physics Group				x	x
Smith, Michael H.	(UMIST)	Atmos. Physics		x			
Spiel, Donald E.	(NPS)	Environmental Physics Group		x			
Starkey, Graham	(Soton Univ.)	Dept of Oceanography		x	x		
Yates, Melanie D.	(IOS)	Marine Physics					x

SHIP'S PERSONNEL

Jonas, N.	Master			x	x	x	x
Louch, A.	Chief Officer			x	x	x	x
Oldfield, P.	Second Officer			x	x	x	x
McGill, I.	Chief Engineer			x	x		x
Byrne, P.	Chief Eng.(3)/2nd Eng.(1,2 & 4)			x	x	x	x
McMees, F.	2nd Eng.(3)/3rd Eng.(1,2 & 4)			x	x	x	x
March, P.	3rd Engineer					x	
Wiseman, D.	Bosun			x	x	x	x
Biggs, P.	Seaman			x	x	x	x
Trevaskis, M.	Seaman			x	x	x	x
King, K.	Seaman			x	x	x	x
Owen, D.	Seaman			x	x	x	x
Nicholls, J.	Seaman			x	x	x	x
Peters, K.	Cook/Steward			x	x		
Thomas, A.	Cook/Steward					x	x
Brigham, P.	Steward			x	x	x	x
Miller, S.	Steward			x	x	x	x

INTRODUCTION

This cruise was undertaken as part of the HEXOS (Humidity EXchange Over the Sea) main experiment, HEXMAX. The overall aim of the HEXOS programme is to improve our knowledge of the transfer of water vapour and heat between the ocean and atmosphere, particularly in moderate to strong winds. The HEXMAX experiment was based around the Meetpost Noordwijk (MPN), a meteorological station situated on a tower a few kilometers from the Dutch coast (52deg 16'26" N, 4 deg 17'46"E, see figure 1). HEXMAX participants were stationed on MPN, on the Dutch coast (where radiosonde and tethered balloon measurements were performed), on the U.K. Meteorological Office C130 Research Aircraft, and on the Frederick Russell.

The advantage of using a stable platform such as MPN is that flux determinations can be made using the eddy correlation technique, a method which is difficult or impossible to implement on a ship. However, there are also disadvantages. Because many of the instruments were mounted on a specially constructed boom extending from the west side of the tower, the main measurement periods on MPN were restricted to winds having an eastwards going component. Also MPN is sited in relatively shallow water (about 20m) and in a region where significant horizontal changes in sea surface temperature and salinity occur. An important rôle for the Frederick Russell was to obtain the equivalent ship-based measurements to those obtained on MPN, and to determine the environmental conditions to the west of the tower, hence allowing estimates of the representivity of the MPN results. The ship operated in the neighbourhood of MPN and at a site 72km to the WSW of MPN where the water was deeper (about 30m) and remained deep for some distance upwind. This will be referred to as the "Deep Water Site", DWS (figure 1).

The deployment of instrumentation on the Frederick Russell is shown in figure 2, while appendix 1 summarizes the activity onboard ship during the cruise. Wave conditions were determined both at MPN and the DWS and the sea surface temperature surveyed, using in situ and infrared techniques, at both sites and within the region between. Meteorological measurements were obtained which will allow the humidity and momentum fluxes to be estimated both from the mean values of the standard meteorological variables, and by using the inertial dissipation technique. The spectra of aerosol particles was measured to determine the particulate fluxes. The depth of the atmosphere through which these fluxes were being distributed was estimated using radiosonde ascents (listed in appendix 2).

The weather during HEXOS proved ideal for the experiment with many periods of westerly winds of Beaufort force 7 or more, and with force 11 winds experienced during one depression. The Frederick Russell weathered each of these storms well, remaining on station throughout, and with the measurement programme proceeding as planned. Preliminary analysis performed during the cruise indicates that the majority of the data collected are of good quality and it is believed that, following detailed analysis, the HEXOS experiment will prove to have been very successful.

In addition to IOS, groups participating on the Frederick Russell were the Department of Oceanography, Southampton University; the Atmospheric Physics Research Group, University of Manchester Institute of Science and Technology; and the Naval Postgraduate School, Monterey, USA.

NARRATIVE

Mobilization commenced in Great Yarmouth on Monday 6th October and the Frederick Russell sailed at 0830Z on Saturday 11th October (day 284). This relatively long mobilization period was required because of the large number of meteorological sensors which were to be mounted at various positions about the ship (table 1 and figure 2). This included erection of the 10m high IOS meteorological mast on the foredeck, 2m aft of the bow.

The Frederick Russell anchored near MPN by 1900Z/284 and during the morning of day 285, Taylor, Guymer and Spiel attended an ad hoc planning meeting on MPN. At 0500Z/286 the ship proceeded to Scheveningen and collected a Waverider receiver and buoy, owned by KNMI, which was then deployed at 1632Z/286 in 30m of water at 52deg 7.8'N 3deg 15'E, thus defining the DWS to be a few km SW of the planned position to avoid shipping routes. The Frederick Russell remained at anchor near the buoy until 1140Z/287, and, apart from moving closer to MPN for a radio conference during the evening of 288, remained hove to in the region of the buoy until 1200Z/289. During this period a scientific compass was calibrated, and the first strong winds experienced, a force 8 northerly on 288.

By this time a standard working method had been adopted which was used for the rest of the cruise. The alignment of instruments on the IOS 10m mast, particularly of the Lyman-Alpha Humidiometer, required that the wind be within +15 degrees of the bow. Since the currents at both DWS and MPN reach a few knots

this could not be achieved by anchoring. Therefore the method adopted for flux measurement was for the ship to remain "hove to", typically with 1 or 2 knots way, until the edge of a box of about 15km north/south by 8km east/west (defined by the Decca Navigator grid) was reached. Usually this would take 2 to 3 hours and the ship would then reposition at full speed taking typically about 30 minutes.

Arriving at MPN at 1600Z/289, intercomparison measurements were carried out, the Frederick Russell anchored overnight, and, in light offshore winds, the first SST survey in the MPN area was completed on 290 before returning overnight to the DWS. The remaining days of the first leg of the cruise, 291 to 294, were spent on station at the DWS. Strong winds were experienced on day 292 with gusts to 35m/s during a squall, and on 293 with winds of 20 to 30m/s (force 9 to 10 Beaufort) much of the time. During this storm the meteorological tripod which had been placed shoreward of MPN by HEXOS participants from the Institut fur Meerskunde, Kiel, collapsed, and houses and trees in Noordwijk were reported to have suffered structural damage. The wind had decreased to 15m/s when the Frederick Russell returned to Scheveningen at 0830Z/294 for a scheduled port call.

The in-port period was extended overnight to allow more time for instrument maintenance and the second leg of the cruise began at 0800Z/295 when Frederick Russell proceeded to MPN to conduct flux measurements during the first C130 flight day. The ship remained "hove to" throughout the day and, in the 8 to 10 m/s westerly winds, by 0600Z/296 had reached the DWS. Days 296 to 299 were spent on station at the DWS, with winds of 15 to 20m/s experienced on day 296 and overnight on 297/298. The Frederick Russell returned to MPN in the afternoon of 299 and advantage was taken of the calmer weather on days 300 and 301 for instrument servicing and comparison measurements with MPN. On day 302 the second HEXOS flight of the C130 aircraft occurred, however the decision was made to stay at MPN, rather than proceed to the DWS as required by the HEXOS plans, since there had not yet been any flux comparisons with the instrumentation on MPN in stronger wind conditions. These data were obtained on days 302 and 303 and from 2300Z/303 the ship remained hove to, progressing northeastwards until 0400Z/304 when speed was increased and the DWS reached at 0720Z/304. Measurements continued at the DWS until 0330Z/305 when the Frederick Russell departed for Scheveningen at the end of leg 2.

After two hours delay while extra computer discs were unloaded from the ferry, the Frederick Russell sailed at 1030Z/306 for the third leg of the cruise. The measurement programme continued at MPN from day 306 to 310, except for the period 1900Z/307 to 0700Z/308 when the Frederick Russell proceeded slowly upwind to the DWS, visually checked the Waverider, and returned to MPN by 1100Z/308. SST surveys were conducted on days 308 and 310, while on day 309 advantage was taken of the 12 to 15m/s winds to obtain flux measurements close to MPN. These tasks completed, days 311 to 315 were spent at the DWS taking flux measurements in the continuing moderate to strong winds. Conditions varied between warm and cold sectors with a marked cold front passage on one day (312). At 1330Z/315 the C130 was observed over the DWS on the third HEXOS flight. The Frederick Russell left the DWS at 0300Z/316 for the last scheduled port call, entering Scheveningen at about 0900Z. As with the first port call, it was considered worthwhile to remain in port overnight thus allowing more time for maintenance and calibration.

Leaving Scheveningen at 0830Z/317, the final leg of the cruise began when the Frederick Russell passed HMS Ark Royal and commenced an SST survey in the MPN area. This survey was extended overnight out to the DWS and hence to a point beyond the Noord Hinder light, some 37km to the southwest of the DWS. The Waverider was sighted at 0700Z/318 and the SST survey then continued back to MPN along a track about 7km north of the direct DWS/MPN route. The calmer weather on days 318 and 319 was used for instrument testing, including recalibration of the scientific compass, before returning to the DWS overnight on 319/320. A lull during the morning of day 321 allowed the Waverider buoy to be successfully recovered using the ship's boat although the decision had to be made not to recover the mooring line. The wind then freshened giving an opportunity for further good measurements on day 322, with force 9 to 10 gales during the night of 322/323. The Frederick Russell left the DWS at 1740Z/323 and proceeded once more via the more northerly route to MPN where a final SST survey was completed before heaving to at 0300Z/324.

During the morning of 324 the Waverider and receiver were transferred to MPN using the ship's boat and P.K. Taylor made a brief visit to the platform. The rest of the day was spent hove to in the vicinity of MPN while the C130 flew the last HEXOS mission, thus providing a last set of comparison measurements. During this period there were a large number of trawlers in the vicinity and it was occasionally necessary to take avoidance action. The cruise was scheduled to end on the morning of day 326, however because of a forecast of very strong winds the

decision had been made to dock during the previous evening. The Frederick Russell left MPN at 0600Z/325 and headed west making SST measurements to a point about 37km west of the DWS before heading for Great Yarmouth and entering port at about 1800Z/325 at the end of the cruise. By 1800Z/326 the scientific equipment had been dismantled and removed from the ship.

METEOROLOGICAL CONDITIONS

At the start of the cruise (days 284 to 290) the weather was dominated by anticyclones giving fine calm conditions. Weak fronts from the SW on day 287 brought a temporary break with some rain and fog and introduced cooler air from the NW with 12 m/s winds and 2m waves. On day 291 the high pressure area moved rapidly east and a cold front passage was followed by force 8 westerly winds. A much more mobile westerly airstream was then established until the end of Leg 1 (293). A particularly vigorous squall at 1620Z/292 was accompanied by severe lightning and heavy rain with gusts to 60kt and a temporary wind veer of 50 deg. During day 293 an intense low, which had moved rapidly east across the Atlantic passed just to the north giving the strongest winds of the cruise (force 11) behind the cold front.

The weather in Leg 2 (days 295 to 305) was characteristic of a mobile westerly type with a succession of frontal systems passing through the area. A complex low which had given heavy rain during the in-port period cleared away to leave a showery north-westerly and on day 297 a force 8 southerly developed ahead of an occluding front, which passed through the next day. After a short lull a gusty, showery, airflow became established to be followed after a transient ridge on 299 by another frontal system, again bringing strong winds. This system affected the area from day 300 to early on 302 and on 301 there was fog with drizzle in the warm sector. Behind the cold front there was suppressed convection but on 303 an occluding front resulted in freshening southerly winds and rain and then a return to cold sector conditions on the 304.

In Leg 3 (days 306 to 316) the tracks of the main depressions were further north and, although still a mobile westerly pattern, the weather in the southern North Sea was less severe than before. On day 306 the vessel experienced rough seas (5m waves) in a cold, showery northerly following a depression which had traversed the area during the in-port period. Winds died down very quickly the following night under a ridge (to flat calm at one stage) before increasing from

the south to 12m/s. A frontal passage early on day 308 was followed by light to moderate winds. Further fronts on 309 were weak due to an anticyclone over southern England but by the next day the wind had veered to north-westerly with cumulus and stratocumulus as a weak ridge passed. Rising temperatures and increasing cloud on day 311 heralded a change to warm sector conditions; the cold front passage at 1020Z/312 was accompanied by a very sudden change in wind direction from 190 to 290 degrees and a 4C temperature drop. This resulted in confused seas for a while but then a 4m swell from the NW set in. The night of the 312/313 was particularly clear. Winds then increased from the south reaching 17m/s by 1200Z/313 and by midnight it was raining. The cold front initially went through on the evening of the 314. However, it became slow moving and winds remained from a southerly point as a developing wave brought warm sector conditions back across the area.

The weather during the final leg (days 317 to 325) was characterised at first by weak frontal activity followed by the passage of a storm towards the end. There was no low cloud on day 317 but as a cold front approached from the west upper cloud increased and rain started at midnight. The clearance after the cold front at 0300Z/318 was short-lived because a small depression from the SW began to affect the area later in the day. Behind the cold front, which crossed on the morning of 319, moderate cumulus occurred with 8m/s westerlies. Although winds backed to southerly, conditions remained fine until the cold front of a depression centred near Iceland brought increasing cloud. The passage of this front introduced a very showery period, with a tendency for the showers to be organised within troughs. Winds increased to 20m/s until after the final trough a temporary lull occurred on the afternoon of 322. Later the wind backed to southerly and increased to 23m/s by 0300Z/323 due to the close proximity of a vigorous, open-wave depression just to the north and 5m waves were reported. Behind this system the winds dropped very quickly and veered from SW to NNE. This produced some of the lowest temperatures of the cruise on 324 with 4C air-sea temperature difference and much convection.

SCIENTIFIC PROGRAMME REPORTS

1. WMO OBSERVATIONS

A 3-hourly series of surface meteorological observations was maintained throughout the cruise for the purposes of checking the various automatically-

recording instrumentation and to monitor synoptic-scale developments. Observers followed WMO conventions in recording cloud amount and type, wind wave and swell conditions, wind velocity, dry-bulb, wet-bulb and sea-surface temperatures, barometric pressure, visibility and present and past weather. Relative wind and ship's velocity through the water were both noted so that the dependence of parameters on air-flow over the ship could, at a later stage, be examined. Air temperatures were obtained from the screen thermometers, used by the bridge officers for their standard reports, and from an Assman psychrometer. The latter was initially a clockwork version but after difficulties were experienced with the speed of the fan the upper part of the body was replaced on day 296 by an electrical fan assembly provided by the UMIST group. This was left permanently switched on and operated successfully until the end of the cruise. The wet-bulb wick was moistened a few minutes before each reading to ensure that an accurate value was obtained.

The Frederick Russell is equipped with a dial readout (which is calibrated in m.p.h., not knots or m/s) only for wind speed and consequently apparent wind direction was obtained from the dial displays connected to the wind vanes erected by the UMIST group. Sea surface temperature was measured in the normal way by lowering a rubber bucket into the water (from the Starboard bridge deck) and immersing a mercury-in-bulb thermometer on its retrieval. These data were compared with the Deck CTD output and occasionally large differences were found. Most of these appeared to be due to the observer not keeping the bucket in the sea for an adequate time to allow it to adjust to the SST when it had been lying on deck in cold, dry air. For pressure, uncorrected values from the Precision Aneroid Barometer on the bridge were used. As an aid to estimating visibility radar fixes on the many ships in the area were combined with visual sightings. The most difficult observations to make, not surprisingly, were the subjective ones of cloud and sea-state conditions. To a large extent these depend on the experience and keenness of the observers but it is believed that a useful data set has emerged. Night-time reports (1800-0700) were particularly difficult to make.

Met observers: S. Fellbaum, T.H. Guymer, M.K. Hill, P. Park,
C. Skupniewicz, M.H. Smith, D.E. Spiel, G. Starkey, M.D. Yates

2. RAIN GAUGES

The principal objective was to assess the effects of location and rain-gauge design on the amount of rainfall collected. Two types of rain-gauge were provided by the Institute of Hydrology, Wallingford: a 'standard' one in which the funnel is contained within a cylinder and a 'champagne' style in which the collecting pan is elevated above the rest of the instrument. The latter is thought to be more efficient at collecting rain in strong winds. Three such pairs were deployed at the following locations: one set on the cross-trees of the main mast, one on the forward port wheelhouse top and the other as far aft as possible on the bridge deck. For the mast mounted gauges plastic pipes were run from the collecting funnels on the mast to the main body of the gauge located on the wheelhouse top for ease of access.

It was originally planned that gauges would be read every 6 hours but, given the difficulty in emptying the contents into a measuring cylinder and reading the volume in the rough conditions accompanying some of the rain events and the fact that very often accumulations over a few hours were too small to measure accurately, the gauges were emptied at intervals varying from 3 to 48 hours, depending on circumstances. Problems were experienced with the pipe from the champagne-type gauge on the mainmast being pulled out of the bottle on two occasions and also with leaks in the canisters holding another of the bottles. Only the first is believed to have resulted in error. A preliminary examination of the readings suggests that the mast gauges collected more rain than the others but with large variability and that champagne-type collectors do indeed result in slightly greater volumes being collected.

T.H. Guymer

3. IOS METEOROLOGICAL MEASUREMENTS - MULTIMET SYSTEM A

3.1 Introduction

This was the first cruise on which the new IOS Meteorological data logging system, "MultiMet", had been used to collect data for scientific purposes (an engineering trial was carried out in March this year on Discovery Cr.159). Two MultiMet systems were used. System A was configured to sample up to 48 channels (of which 36 were used) and record mean values each minute on a Sea Data Series 610 cassette recorder. About 6.5 Mbyte of data were logged during the cruise,

these being transferred onboard ship from cassettes to 9-track Computer Compatible Tape (CCT) using a Seadata Model 12B Replay Unit and a Digidata Series 1100 Tape Drive with 1Kbyte Double Buffered Memory. Real-time data display facilities were provided by a BBC Master microcomputer running the MetMan software system. MultiMet System B was used for the inertial dissipation measurements (see section 4).

3.2 Sensor Deployment

Installation of the MultiMet systems and associated sensor suite was carried out during a four day period prior to the start of the cruise, during which time 0.75Km of multicore cable was used to connect the thirty-six sensors to the central processors located in the Main Lab. The main sites for the sensors were the IOS 10m Meteorological Mast, the wheelhouse top, and the main mast (figure 2).

The IOS 10m Mast was mounted on the foredeck, amidships, 2m from the bow, stabilised by four stays at forty-five degrees to the fore & aft line of the ship. The Mast was operational throughout the cruise, and withstood many periods of high wind conditions (up to force 11). The instrument carriage whilst at the mast head was subject to considerable vibration at high wind speeds. Reduction of the carriage structure achieved a decrease in windage and minimized the vibrations to the least possible within the mechanical limits of the construction. Lowering of the instrumentation carriage was prevented by safety considerations in high sea states. This limited the occasions when the NPS Lyman-alpha humidimeter could be serviced, but otherwise did not result in long periods of data loss due to inability to service the sensors.

A 4m mast was mounted on the forward wheelhouse top rails at a position 3.5m from the port side and 1m aft from the forward edge of the bridge during legs 1 & 2. For legs 3 and 4 it was moved to 1.5m from the port side. Stephenson Screens were mounted on each side of the wheelhouse top, being attached to the rails 0.5m from the port and starboard sides and 3m from the forward edge of the bridge.

3.3 Wind Speed & Direction

A Gill type propeller-vane anemometer (manufactured by R.M.Young) was mounted on the upper arm of the 10m mast instrument carriage so that the sensor head was about 0.5m above the mast top. This instrument had no periods of failure during the entire cruise withstanding the extreme conditions encountered.

Vector Instrument anemometers and wind vanes were initially deployed at four locations, chosen to provide good exposure for at least one instrument set for almost all relative wind directions:

- i. the upper arm of the 10m mast instrument carriage,
- ii. at the top of the 4m mast,
- iii. the lower arm of the upper cross trees on the starboard side of the ships main mast,
- iv. a 3m scaffolding mast on the starboard aft A-frame platform.

To decrease windage, the wind vane was removed from the 10m mast at the end of phase 1, the anemometer being kept there for comparison with the Gill propeller sensor. However the anemometer too was removed after 6th November. The zero position for the orientation of these wind vanes had been accidentally changed when the vanes had been oil filled at IOS prior to the cruise, so the wind vanes each had a different, but constant, offset. Otherwise there were no malfunctions for these sensors.

Two Brookes & Gatehouse sensor units had been provided by the manufacturers for evaluation purposes. These were mounted on the 4m mast, the uppermost unit at the top of the mast worked throughout all legs of the cruise, however the lower unit was not water tight and worked only intermittently despite constant servicing.

3.4 Aspirated Psychrometers

Four Aspirated Psychrometers were operational throughout the cruise:

- i. A Delta 'T' sensor in the port Stephenson Screen.
- ii. A Delta 'T' sensor in the starboard Stephenson Screen.

- iii. A Vector Instrument sensor mounted on a horizontal boom from the 4m mast, 2m above the the deck. For legs 1 and 2 the boom projected forward 1m. When the 4m Mast was moved for legs 3 and 4 the boom was lengthened to 2m and deployed directly to port.
- iv. A Vector Psychrometer was mounted on the upper arm of the 10m mast instrument carriage.

At the completion of the first leg the Psychrometer on the 4m mast was replaced, because of instability in the sensor signal conditioning electronics, by the spare Vector Psychrometer. The original sensor was returned (at the end of leg 2) to IOS for investigation. The 10m mast sensor was consistently found to read about 0.3C colder than those on the Wheelhouse top and on day 319 the 10m and 4m mast sensors were exchanged. The new 4m mast sensor now also developed instability in the signal conditioning electronics, resulting in a few tenths degree offset. A radio message from IOS later revealed that this instability was cause by a corroding earth contact, the assessment of overall effect on the data quality will await further investigation.

3.5 Humidity Sensors

Two Vaisala Humicap Type 12U (heated) sensors were deployed for evaluation purposes, one situated in the starboard screen and the second in a "stack of plates" screen on a 2m pole clamped to the forward wheelhouse top rails (2.5m from the port side and 1m aft of the forward edge of the wheelhouse). The latter sensor functioned continuously, however the data values are offset compared to other measurements and post-cruise recalibration is needed. The starboard sensor was unreliable especially in high humidity conditions and was augmented for part of the cruise by a Vaisala radiosonde (which uses an unheated Humicap sensor).

3.6 Sea Surface Temperature

Two booms were mounted on the foredeck just forward of the accommodation to provide towing points, on the starboard side for the SST Fish, and on the port side for the SST trailing thermistor (the "Soap-on-a-Rope").

The SST Fish suffered three towing cable faults during the cruise. Leaks in the cable joints twice allowed water to enter the back of the 4 Pin Brantner connector, shorting out the electrical connections. Finally during the last week

of the cruise the cable failed under the continuous mechanical stressing and the time remaining was not considered long enough to justify a repair. However, otherwise during deployment, the SST fish towed well and provided good data.

Evaluation trials of the Soap-on-a-Rope, a cheap SST sensor, were continued during the cruise. The design uses a thermistor bead mounted on two core divers-line towing cable connected to a deck-mounted SST Fish electronics unit. The first sensor cable lost calibration after initial trials, due to water penetrating the towing cable, however the second cable lasted until the last few days of the cruise giving good data and encouragement as to the design's long term potential.

3.7 Radiation Sensors

Upward looking long wave (Eppley) and short wave (Kipp & Zonen) sensors, mounted on the roof of the Wheelhouse top Control Cab, functioned without any faults throughout the cruise. However the gimbal mountings for each of the units will require redesign to allow the sensors to function correctly. Friction on both axes of the Eppley gimbal mounting was too high to allow the sensor to maintain a vertical orientation. Side plates, fitted to increase the bearing surface area of the annular rings, caused distortion and resulted in misaligned bearing surfaces and hence increased gimbal friction. On the Kipp & Zonen sensor gimbal unit the retaining ring, which limits the excursion of the pendulum, caused distortion of the vertical supports and hence the bearings were misaligned. These problems were reduced for the last leg of the cruise by loosening and realigning parts of the mounts.

3.8 Ship's Head

An RVS Level 'A' Interface was specially fitted for this cruise to produce 1 minute running mean values from the ships gyro compass. Failure of the gyro interface, due to internal hardware timing, required the Level 'A' to be reset frequently. Subsequently the gyro interface malfunctioned and was changed under instruction from RVS, however the new unit also appeared not to track correctly. It was only during a compass swinging exercise on day 318 that it was discovered that the new unit was actually able to track changes in the ship's gyro reading, but that it was wrongly wired and showed rotation in the opposite direction to reality.

It is not yet known to what extent the gyro data can be salvaged and ship's head information may only be available from a magnetic compass. Initially attempts were made to site this on the wheelhouse top but no position that was reasonably free from magnetic disturbance could be found and the optimum place appeared to be on a bench in the main lab. Compass swinging exercises were conducted on days 287 and 318, however readings at other times may have been affected by the movement of objects within the laboratory, in particular one of the metal framed chairs. Care will be therefore be needed in using the data.

3.9 Precipitation Detector

Because the sensor was under evaluation, the choice of deployment position was constrained to those allowing ease of access, and for this reason the sensor was mounted on the aft end of the Bridge deck rail. The detector was operated in continually heated mode to ensure rapid response to changes in environmental conditions, however the sensor was found to have major deficiencies. In the shipboard environment the heating of the sensor was insufficient, thus rain was indicated for an indefinite period after the end of precipitation, or even when no rain had actually occurred. In an attempt to remedy this a screen was placed around the sensor to minimize the cooling by the wind. Whilst this solution improved the sensor resolution there was still insufficient heating in high humidity conditions (>80%) to prevent erroneous indication of precipitation. To improve the signal to noise ratio the sensor was placed in an enclosed container (an empty biscuit tin) with an external collector (a plastic funnel), however insufficient data was obtained to fully evaluate this method of deployment.

3.10 Electromagnetic Log

The ship's velocity relative to the water was recorded by logging the output from the Colnbrook 2-component electromagnetic log which is a standard "scientific" instrument on the Frederick Russell. The state of calibration of the log was not known, however the ship's officers experience suggested that any errors were likely to be less than 10% and therefore negligible when the ship was hove to. Checks were made that the values logged conformed to those displayed on the bridge by using the internal calibration signal. However it did not prove possible to perform any absolute calibration of the log.

3.11 MetMan Software

MetMan is a software package designed to provide real-time Meteorological data management for the MultiMet system. It is run in a BBC microcomputer connected to the MultiMet logger via the RS232 link and provides not only real time data plotting and listing facilities but also maintains other text files, for example, a data description file containing sensor calibration and channel connection details.

At the start of the cruise programming priority was given to developing plotting programs for systems such as the On-deck CTD, Radiosondes, and Multimet-B, for which no software was available. Use of the MetMan user-interface and plotting utilities speeded development of these programs, however the MetMan system itself was not fully implemented until day 308. It then proved valuable for investigating a number of uncertainties in the sensor calibrations, particularly by providing time series data plots in an interactive fashion. All the MetMan facilities were not used, partly because with off-line computers available the ability to work in time-sharing mode on the MultiMet-A computer was not needed, but also because the latter facility was sometimes inconveniently slow. This is mainly due to the number of disc transfers needed in transferring between modules and these should be reduced in future implementations. However the flexibility of this modular approach was demonstrated by the ease with which a separately developed real-time display program was added into the logging system.

K.G. Birch, R.W. Pascal, P.K. Taylor.

4. IOS INERTIAL DISSIPATION SYSTEM

This cruise proved the first test of the IOS system for surface stress measurement using the inertial dissipation technique. The sensor used is the IOS 10m meteorological mast Gill propeller-vane (section 3.3) which provides wind speed and direction data. A two component accelerometer was mounted on the same arm of the mast to monitor the ship induced accelerations. The four channels of data were sampled at 8Hz using a MultiMet logger in fast sampling mode and recorded on floppy disc using a BBC microcomputer. Initially there were problems caused by the housekeeping activities of the Acorn Advanced Disc Filing System delaying the BBC to a degree that data cycles might be lost. This was overcome by using a 64K Microbuffer between the MultiMet system and the BBC, and it then proved practicable to record 68 minutes of continuous data on a single disc.

During each of these fast sampling runs the ship was kept hove to with the wind usually within 20 degrees of the bow.

Initial analysis of the data using a software Fast Fourier Transform running on a BBC microcomputer suggested that the inertial dissipation region of the wind speed spectrum could be detected for wind speeds above about 10m/s and below perhaps 20m/s. The lower limit is due to the limitations of the instrument response under light wind conditions, given the deployment height (about 14m). The reason for the upper limit is not clear, increased vibration of the mast carriage is a possible cause but the effects were not consistent with that explanation and further analysis is needed. Despite the limitations it was considered worthwhile to obtain as many samples as possible in all wind speeds above 15m/s and the high incidence of such conditions meant that a large number of data runs were obtained (appendix 1). The data yield was such that additional discs had to be obtained for each of the last two cruise legs. Since analysis of these data will require the use of a mainframe computer, transcription of the data to 1/2" computer tape was commenced during the cruise using the DigiData tape system, 230 of the 276 discs (each holding up to 0.6 Mbyte) being copied by the end of the cruise.

K.G. Birch, R.W. Pascal, P.K. Taylor

5. NPS TURBULENT FLUX MEASUREMENTS

5.1 Introduction

The Naval Postgraduate School of Monterey, California, USA contributed the services and equipment of the Environmental Physics Group (EPG) to the HEXMAX shipboard experimental team.

EPG's objective in HEXMAX was to collect a good set of moderate to high frequency windspeed and humidity measurements which, when merged with the collective set of shipboard measurements, would provide a data base from which momentum and water vapor fluxes could be calculated via the turbulence dissipation technique.

Guided by this philosophy, EPG chose three instruments commonly used for surface layer measurements of the velocity and water vapor mixing ratio spectra in the inertial subrange; the hot film (wire) anemometer, the low inertia cup anemometer, and the Lyman-Alpha humidity meter (which was graciously loaned by RISO National Laboratories of Denmark). Specifications are supplied in table 5.1.

Table 5.1 Specifications of the EPG Instruments

Instrument	Model	Filter Band
Hot film anemometer	TSI 1210-60	2-20 Hz
Lyman-Alpha humidimeter	ERC BL-17	2-20 Hz
Low inertia cup anemometer	R.M. Young generator	0.2-13 Hz(*)

* actual frequency response of the instrument is variable

5.2 Data processing and analysis

With the advent of high speed Fourier transform software, EPG has chosen to compute power spectra in real time, since virtually no data is lost during the processing. The advantages are threefold; storage requirements are greatly reduced, spectra can be examined in situ (revealing noise problems, etc.), and post-processing procedures are simplified. During HEXMAX, EPG used a 16-bit Ariel brand fast Fourier transform processor board which performed 256 point complex transforms in 1.8 ms. A Hanning window was applied to each data stream before transformation. Data was collected from all three instruments at a 50 Hz rate, making each time series approximately 5 seconds long. Power spectra were computed after each transform, and results were averaged for 10 minute periods. Spectra were then stored on disc and displayed graphically for review. Graphics were also dumped as a hard copy for post-experiment analyses.

In addition to the spectra, EPG also logged 5 second averages of the relative windspeed and direction obtained in analog form from the IOS group's Gill-type prop-vane. The Gill was located immediately above the EPG instrument array. These signals were digitized at the same 50 Hz rate as the turbulence quantities. Concurring measurements of the wind quantities were required for proper screening and as input to the dissipation procedures. Also digitized and recorded were 5 second averages of the d.c. components of each of the three turbulence instruments, needed for calibration purposes. (The d.c. component had to be removed from the transformed signal because of filter limitations.)

Briefly, the pre-digitization processing of turbulence signals consisted of device dependent bandpass filtering in the a.c. case (to avoid aliasing and

leakage) and amplification or attenuation of signals where required (to optimize the digitization).

All data were stored at 10 minute intervals as floating point numbers in voltage units, except for the IOS windspeed which was recorded in m/s. Calibrations will be performed in post-experiment processing. Hot film calibration factors were calculated and stored in situ by regressing the IOS windspeeds versus the hot film d.c. voltages at every 10 minute interval. This quantity was a useful tool in evaluating the hot film performance and was included in the real time graphical output along with the IOS average windspeed for the 10 minute period.

Along with the above described 10 minute records, some of the data files include "fast sampling" records. These records consist of the complete collection of 5 second Fourier transform arrays for the hot film and Lyman-Alpha. Roughly 30 such files exist, with each file containing 1 hour of continuous data. Many of these files correspond in time to IOS "fast sampling" runs described elsewhere in this report. From these data, intermediate lengths of spectral averages can be formed, and it is hoped that individual turbulent structures can be identified and studied in some cases.

5.3 Hot film anemometers

EPG's hot film anemometry system has been used extensively at sea in the past, and these experiences have paid good returns, for this system performed flawlessly throughout the cruise with little maintenance required. In the dissipation subrange, the spectra were clean and straight, except during periods of rain. Probes typically lasted a week or more, and calibration factors were remarkably consistent from probe to probe. A version of the post-experiment dissipation technique analysis program was run during periods of inactivity with HEXMAX data input, and reasonable values for the drag coefficient and the dissipation rate were obtained.

5.4 Lyman-Alpha humidimeter

The Lyman-Alpha humidimeter performed marginally well during HEXMAX. Straight, clean spectra with reliable d.c. values were obtained when the instrument was operating properly. The instrument was, however, very susceptible to breakdown during rainy or very damp periods. Indeed, the original cruise plan called for

Lyman-Alpha operation only when no precipitation was occurring, and protecting the device with a cover during damp weather. This procedure was followed for the first leg of the cruise, but abandoned because of the inability to raise or lower the IOS 10m mast instrument carriage in strong wind conditions. From day 294, it was decided to operate the Lyman-Alpha continuously during the remainder of the cruise until it failed. The result was a dramatic increase in logged data but also the expected increase in instrument failure.

The Lyman-Alpha data quality was also very dependent upon apparent wind direction. A wind vane mounting assembly, although built for the experiment, exceeded the weight limits for the bow mast carriage, and the instrument had to be fixed into a fore/aft alignment. Careful screening of relative wind directions will be necessary during post-experiment processing.

Anticipated problems with the sensor window cleanliness failed to materialize. The d.c. levels, which are a function of window transparency, did change slowly between cleanings, but calibration adjustments should only be required every few hours, based on preliminary estimates. When operating during rain or fog, the windows become coated with liquid water, and the signal proved unreliable.

5.5 Mini-cup anemometers

The low inertia cup anemometers were included in the HEXMAX experiment in order to provide backup to the hot film during rainy periods or breakdown. EPG's experience with high frequency measurements from mechanical devices is rather limited, and the cup/generator combination used must be considered developmental. These facts combined to result in a good amount of highly suspect spectra. During the first half of the cruise, a new rigid plastic set of cups was used in order to avoid breakage in high winds. Unfortunately, the frequency response proved quite poor, and reasonable spectra was only obtained in very high winds (>15 m/s). Polystyrene cups were installed for the second half of the cruise, increasing frequency response dramatically. Unfortunately, these cups disintegrated when winds exceeded 20 m/s. Other problems included low frequency wave energy noise and high frequency generator noise, which often left a very narrow range of unaffected frequencies. Indeed, at times the 2 noise problems converged and left no frequency band unaltered. Since the cups had limited frequency response, it may become necessary to consider power spectral densities at frequencies approaching the lower limit of the inertial subrange. This lower

limit is quite variable; strongly depending on the measurement height and windspeed, and less dependent on surface roughness and stability. Post-experiment processing will have to address all of the above problems and limitations when using the cup spectra. It may be possible to calculate a spectral correction for the generator problem, and thus extend the range of usable frequencies for dissipation estimates.

D.E. Spiel, S. Fellbaum, C. Skupniewicz

6. UMIST AEROSOL AND HUMIDITY MEASUREMENTS

6.1 Introduction

The primary aim of the data collection performed by the UMIST Atmospheric Physics Group was to attempt to increase the understanding of the production and dispersal mechanisms of marine aerosol, by investigating the effects on the aerosol size distribution of the prevailing meteorological conditions. The results will represent a significant extension to those previously obtained from an Atlantic coastal site. Additionally, detailed information on the small-scale temporal variation of humidity was obtained, in order to investigate a possible relationship with atmospheric stability. In spite of this being the first attempt at ship-borne research by the APRG, with the consequent lack of knowledge concerning the suitability of the instrumentation, both aims have been substantially fulfilled. A database in excess of 200Mbytes was accumulated in the process. Figure 2 shows the siting of the UMIST instrumentation.

6.2 Aerosol Probes

Initially, it was envisaged that three sampling systems be operated. Unfortunately, the probe intended to measure the largest aerosol, an Optical Array Probe, was never operational, owing to a series of electronic and laser problems.

The probes which were operated were the Active Scattering Aerosol Spectrometer Probe (ASASP), sizing particles from 0.1 to 3 microns radius in four overlapping ranges, and the Forward Scattering Spectrometer Probe (FSSP), sizing particles in the range 0.25 to 23.5 microns radius in four ranges. Both devices size particles by measuring the amount of light scattered at forward angles as the particle passes through a laser beam. Originally designed for aircraft use, the

FSSP withstood the rigours of the marine environment considerably better than the ASASP, which required frequent cleaning of the optical system. However, of the hours spent at sea, the ASASP was operational for approximately 75% of the time, the FSSP for about 85%. In both cases, difficulties were encountered due to leakage of sea-spray and rainwater into the probe casework and the electrical connectors, of sufficient severity, in the case of the FSSP, to require complete dismantling of the probe. Following this event, the FSSP was prone to occasional fogging of the optical system. Water in the ASASP caused occasional arcing from internal mains supply leads, leading to circuit breaker trips. This probe also suffered two break-downs traced to faulty signal line drivers, and a mechanical breakdown when a glue used to locate an external laser mirror failed.

6.3 Dewpoint Sensors

Three dewpoint sensors were installed to measure humidity fluctuations: a Michell Instruments cooled-mirror device, an E.G. & G. system using the same principle, and a UMIST constructed unit, HICUP, which determines the dewpoint from an auto-calibrating hygristor.

The E.G. & G. ran continuously following a repair during the first week and gave very reliable results when compared to values calculated from screen temperatures. Its frequency response was such that no variations of frequency greater than 0.05Hz could be detected.

The Michell proved very unreliable. Initially installed near the top of the ships mast, the sensing head suffered increasingly frequent breakdowns, until, at the end of the first leg, it was relocated to the radar level to increase accessibility. At the end of leg 2, following further breakdowns caused by rapid accumulation of salt deposits on the mirror and leakage of water into the electronics, the unit was relocated to a housing on the wheel-house top, the sample air being drawn through tubing from the radar level. Although still subject to breakdown, the ease of servicing allowed the instrument to operate for the majority of the remaining two legs. The data obtained shows the device as having a frequency response extending to greater than 1Hz.

HICUP, a device in only its second prototype phase, operated well following correction of a number of faults that occurred in the early stages of the project. Unable always to track the absolute value of the wide range of

dewpoints that occurred (due to underpowered reference coolers), the rapid variations detected by the Michell device were faithfully reproduced, the data obtained showing a frequency response extending to at least 2Hz. Contamination of the sensing hygistor led to this element being replaced on the second and third port calls. The sample inlet hose, initially located near the top of the ship's mast, was shortened during the first port call so that it terminated at the radar level, in order to increase the frequency response of the system.

6.4 Wind & Temperature Sensors

Wet and dry bulb temperatures were recorded throughout the project from a UMIST set of platinum resistance thermometers. Wind speed and direction were recorded from two locations, a direction sensor being mounted above the aerosol probes to determine the orientation of the probes with respect to the wind, with an adjacent speed sensor to assist in determination of the volume sampling rates of the probes. An additional set of direction and speed sensors, located two metres above the wheelhouse top, were used to measure local wind velocity. All sensors functioned without breakdown.

6.5 Ship Sensors

Following problems with the ship-borne wave recorder's chart readout during leg 2, the analog signal from the unit was relayed to the UMIST system and recorded continuously. As an adjunct, the ships fore/aft EM log was recorded.

6.6 Logging System

The Distributed Realtime Input Processing System (DRIPS) logger functioned throughout the project except during port-calls. Three faults occurred: a complete system crash thought to be caused by the change-over of generators at the end of a port-call; a one-off failure of the main mag-tape transport; and an untraceable fault in one of the peripheral processor units which caused the loss of three hours of data.

M.H. Smith, M.K. Hill, P. Park

7. RADIOSONDE ASCENTS

There were two scientific requirements for radiosonde data during the Hexos experiment. First, knowledge of the atmospheric boundary layer structure will aid interpretation of the surface flux measurements; for example it will indicate the depth over which surface produced aerosol particles are mixed. Second, measurement of the structure of the entire troposphere is required for studies aimed at improving the estimation of sea surface temperature from satellite-borne radiometers. For these reasons IOS and NPS jointly mounted a radiosonde programme from the Frederick Russell, launching three radiosondes each day at about 0630Z, 1230Z and 2030Z (see appendix 2).

The cruise represented the first use of the new IOS radiosonde tracking system, which consists of an old Beukers WL-2 tracking system converted by Vaisala to track either Vaisala or VIZ radiosondes. A Vaisala PP11 processor was used to provide calibrated pressure, temperature and humidity readings at one second intervals which were recorded on disc by a BBC Model-B microcomputer and atmospheric profiles of specific humidity, relative humidity, and potential temperature were plotted soon after the end of each flight.

The new system proved a significant improvement on that used previously. The Vaisala RS80-15 radiosondes proved very reliably in use and had the advantage of only requiring a relatively small size balloon (26cu.feet of helium was used for a 200gm balloon). This, together with the use of a Vaisala balloon inflation shelter meant that radiosonde flights could be prepared and launched by one person. Despite the strong winds there were very few failures to successfully launch the balloon.

The Loran-C tracking information was recorded on chart recorder as in the original Beukers equipment. The HEXOS area was outside the normal region of Loran-C coverage and successful radiosonde tracking using Loran-C was not expected. In the event it proved possible to track the 2030Z flight, however radio propagation conditions were such that a suitable combination of stations could not be obtained at the times of the other flights.

P.K. Taylor, D.E. Spiel, K.G. Birch, S. Fellbaum,
T.H. Guymer, R.W. Pascal, J.R. Perrett, C. Skupniewicz

8. SST RADIOMETER

The Department of Oceanography of the University of Southampton deployed a downward-looking infrared radiometer to measure the radiative sea surface temperature. The aim was to investigate the difference between the skin temperature, as seen by satellite borne instruments, and the "bulk" sea surface temperature as measured by buckets or other devices. The radiometer had been designed and constructed by the University of Oxford with assistance from the Rutherford Appleton Laboratory.

The Radiometer was mounted in an aluminium frame work, which was suspended from the Hiab Crane on the port side of the Bridge Deck, with a horizontal supporting pole clamped to the aft edge of the hydrographic davit. Deployment and recovery were performed by the ship's crew and their careful handling under all conditions of this relatively fragile instrument is gratefully acknowledged. The sensor was inclined outboard at an angle of about 15 degrees to the vertical, looking down at the sea surface from a height of 5m with the detectors footprint center about 3m from the ships side. In this situation the field of view of the radiometer tended to be filled by foam from the bow wave when the ship was steaming, and undisturbed water when the ship was hove to. All water outlets from the ship were on the starboard side. Due to the Radiometers open construction, and the possibility of immersion or damage by spray, it was considered unwise to deploy it in severe weather conditions.

During the cruise the Radiometer suffered from a number of electronic problems, which caused it to work incorrectly. This mainly concerned the operation of the reference black bodies used for calibration, particularly in the positioning of the bodies, and their temperature control. It was also found that a large amount of electrical interference was introduced onto the power supplies by the chopper circuits, this contaminated the analogue signals producing corrupted data. Many if not all of these electrical problems were attributable to the instrument's poor electronic layout.

Eradication of the many problems appears to have been achieved by the end of the 3rd leg, allowing the radiometer to produce plausible results throughout leg 4. It remained the case that the radiometer produced noisy results in rough weather or occasionally when the ship was steaming, however this may have been due to the

Radiometer seeing white water under these conditions.

G. Starkey, R.W. Pascal, J.R. Perrett

9. SEA SURFACE TEMPERATURE AND SALINITY MAPPING

A potential source of differences in the fluxes as measured at the DWS and at MPN would be changes in atmospheric stability caused by variations in the sea surface temperature (SST). In addition to the SST measurements by the Multimet instruments and the IR radiometer, the SST and salinity were measured using an on-deck CTD system supplied by RVS. This instrument was connected to the ship's non-toxic seawater supply and was operated almost continuously during the cruise except for periods from day 319 onwards when the ship was hove to since occasional blockages of the non-toxic supply had begun to occur. Seawater samples were collected to allow post-cruise calibration of the salinity values. The CTD data were recorded on floppy disk using a BBC microcomputer.

Since the greatest variation was observed in the region around MPN several surveys were conducted in that region. SST data at the DWS were collected while the ship moved about within the 15x8km station area. Figure 3 summarizes the results in terms of a temperature salinity diagram, for clarity only SST surveys on days 290, 300, 308 and 316 are shown. At the DWS the temperature and salinity varied little with position. However the sea temperature became colder throughout the experiment at a rate which was similar to that which might be estimated from the observed surface fluxes. Similar cooling occurred in the region of MPN where the water also showed a tendency to become colder and fresher compared to the DWS. The average temperature change within 20km west of MPN was an increase of about 0.6C. The increase over the further 54km to DWS was 0.4C and this increase continued to the west of DWS. Air reaching each of the measurement sites was therefore becoming more stable, however on most of the measurement days this change was not sufficient to reverse the sign of the stability.

(Met. Observers)

10. WAVE MEASUREMENTS

In addition to visual estimates of wave parameters, data from two instruments were logged on the Frederick Russell. The first was a Ship-Borne Wave Recorder (SBWR), the output of which was manually recorded in analogue chart form and

automatically as processed Fast Fourier Transforms on cassette. The other was a Waverider buoy supplied by KNMI which was deployed by the Frederick Russell at the Deep Water Site. These data were also recorded on the cassette but only when the buoy was within VHF range. The automatic sampling was programmed at the start of the cruise to be carried out at 3-hourly intervals (00, 03, 06GMT, etc). This was supplemented by operating the analogue chart-recorder for the SBWR every 3 hours, halfway between these times, since 3 hours was considered barely adequate for a coastal site with rapidly changing winds and tidal currents.

Problems were experienced with uneven running of the SBWR chart drive which could not be solved by simple maintenance. From day 306 it proved possible to connect into the analogue output of the SBWR and to log the data continuously (after A/D conversion) using spare channels on the UMIST data-logging system. This was only done after extensive comparisons had been made with the chart records. The main problem with the Waverider data concerned the relay in the receiver which was in the habit of jamming if signals had not been received for some time e.g. when the vessel had moved away from the Deep Water Site. An effective remedy was to strike the receiver unit firmly at the rear left hand corner, following which it would lock on to the signal.

(Met. Observers)

11. DECCA NAVIGATOR SYSTEM

The requirement to log the ships speed and position was satisfied by using a BBC Model B microcomputer based logging system supplied by the Shipboard Computer Group of RVS. A Decca Data Acquisition Module, connected to the Decca Navigator repeater in the main Laboratory, was connected, through a Decca to V24 Interface, to the RS423 input of the BBC microcomputer. Provision for mounting this, and other RVS supplied equipment, had not been made, but fortunately it was possible to install the whole system, together with the RVS Level-A Gyro interface in a spare IOS BBC-Master Computer Rack.

The Decca phase readings for each of three chains were logged on disc every 10 seconds for later processing into speed and position. Using 80 track DFS format discs, each disc lasted about 28 hours. A few initial bugs in the supplied software were easily corrected, however a successful method of exchanging data discs was not discovered and it was necessary to stop the data logging when

changing discs. This was not a serious problem however and otherwise the system ran reliably throughout the cruise.

P.K. Taylor

12. IOS SHIPBOARD COMPUTING

The shipboard computing facilities used by the IOS group on this cruise consisted of five BBC microcomputer systems used either for real-time data logging or for off-line processing. In addition, RVS provided BBC micro based systems for logging the Decca and CTD instruments and the University of Southampton IR SST instrument also used a BBC micro for control and data logging. This standardization on a single type of microcomputer system occurred fortuitously but proved to be a great advantage on the cruise.

The plan was to use the IOS systems as follows:

No.	Type	Purpose
1	Model B	Data logging for MultiMet System B ("fast sampling" system)
2	Master 128	Real-time display for MultiMet System A (mean meteorological values)
3	Model B	Data logging for the radiosonde system.
4	Master 128	Off-line data analysis and plotting.
5	Master 128	Off-line analysis and word processing.

In the event, system 1 developed memory faults and was relegated to use for word-processing and other off-line tasks; data logging for MultiMet system B and the radiosondes being continued by system 3 on a time-share basis. Also the unexpectedly large amount of data collected by MultiMet B resulted in BBC system 5 being fully utilised in transferring fast sampled data from disc to CCT during the latter part of the cruise. However these problems only served to emphasize the flexibility achieved by using a number of microcomputers to provide shipboard computing rather than relying on one or two minicomputer systems. It proved possible to produce plots of large enough samples of each data stream on a regular basis to effectively monitor the data quality in near realtime. It was

also possible to perform significantly more ship-board analysis than has previously been possible for meteorological data. Finally, it was possible to type and edit the contributions to this cruise report whilst still at sea.

The main restriction found in using the BBC systems was the time taken to read the MultiMet system B data from disc and to perform the required Fast Fourier Transforms in order to obtain the power spectrum. A more powerful dedicated system is required for this in future. Data plotting was normally performed by writing the graph to the screen and then dumping the screen to the printer. This was comparatively slow, however modification of the software to plot directly to an Epson HI-80 plotter did not produce the expected increase in speed, mainly because of the time taken to read the data from disc. For the future more care in choosing properly blocked data formats on disc could pay dividends. Such a "blocked" format is used by the MetMan software used with MultiMet system A and this proved very efficient for later data recovery and plotting.

K.G. Birch, R.W. Pascal, P.K. Taylor

Figure 1. Position of the main working areas during the cruise (DWS = Deep Water Site, MPN = Meetpost Noordwijk, Sch = Scheveningen) The pecked lines show the approximate limits of the positions occupied when on station at the DWS and during SST surveys at MPN, and the nominal track between the two. The actual track varied from about 3 nautical miles south to 10 nautical miles north of the nominal track.

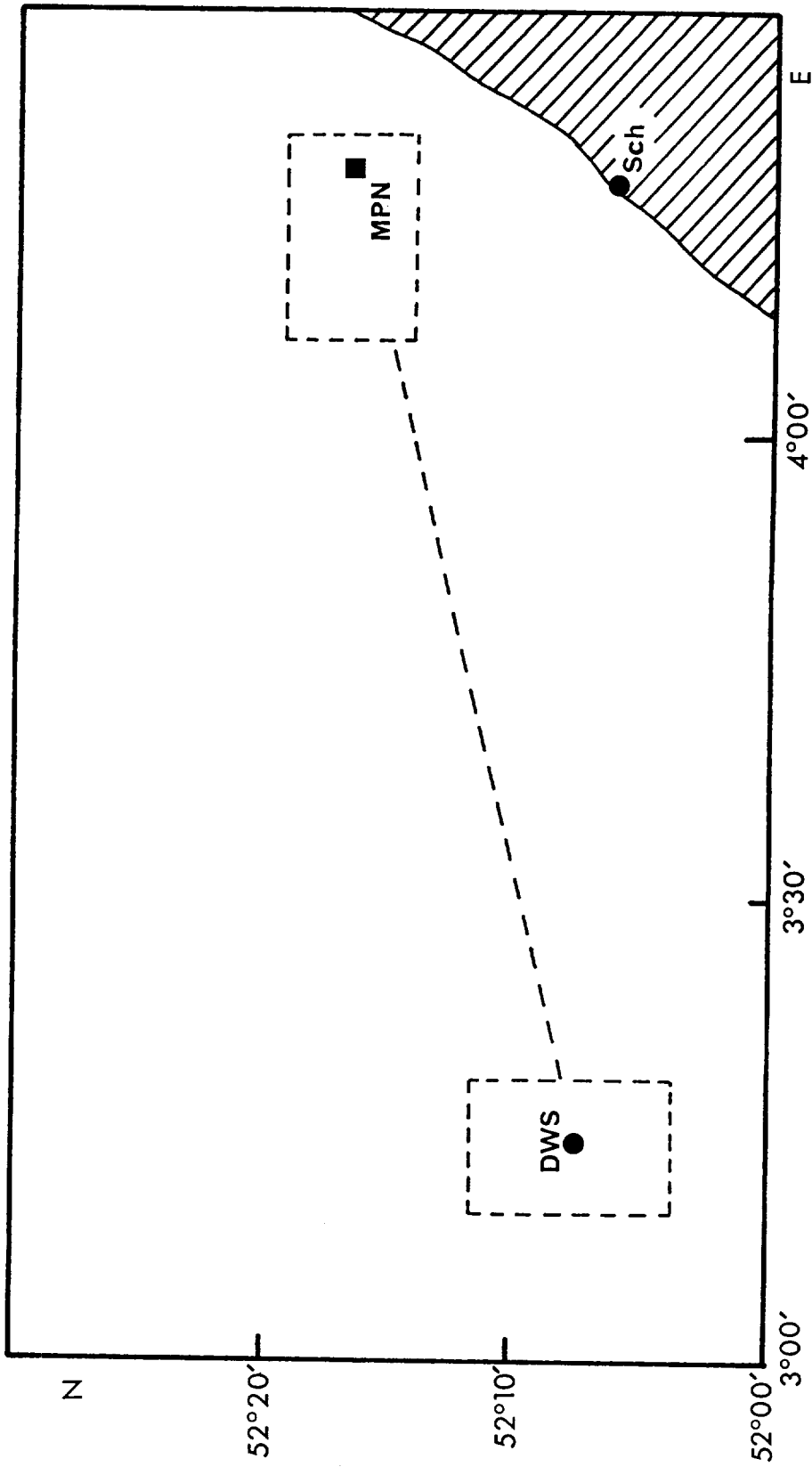
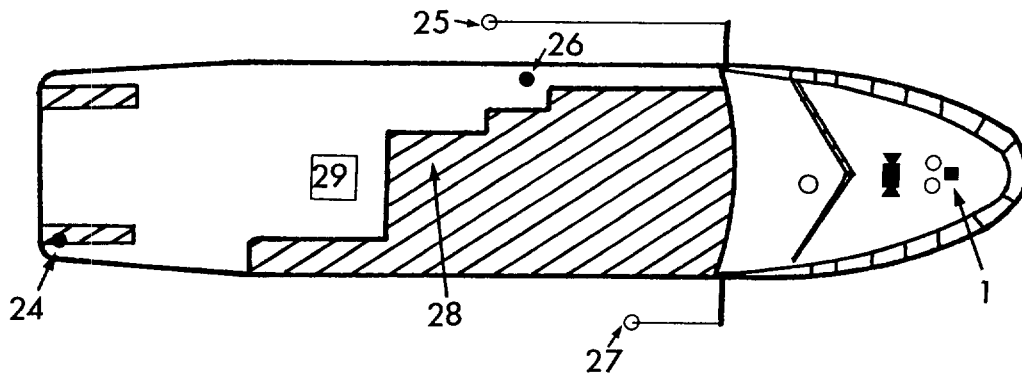
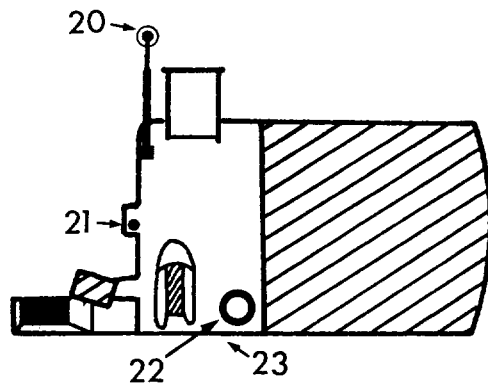
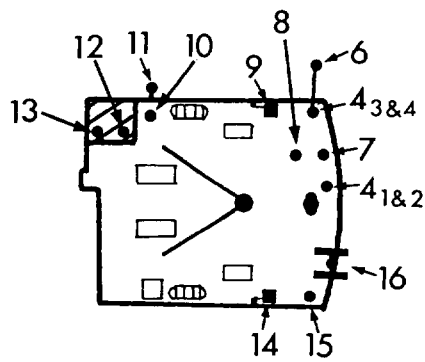
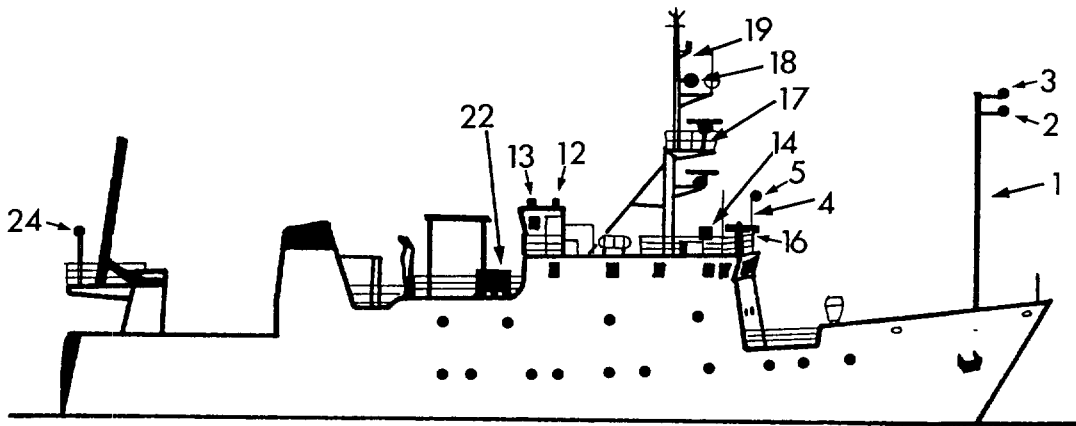

Figure 1

Figure 2. Deployment of instrumentation on the Frederick Russell.

Key:

1. IOS 10m mast
2. (Lower arm of instrument carriage) NPS turbulence probes: Lyman-alpha humidimeter, hot film probe, minicups.
3. (Upper arm of instrument carriage) IOS instrumentation: R.M.Young Gill propeller-vane anemometer, Vector Instruments aspirated psychrometer, Vector Instruments anemometer (until day 310) and wind vane (leg 1 only), two-component accelerometer.
4. 4m mast carrying IOS instrumentation (near centre line for legs 1 and 2, at port side for legs 3 and 4)
5. (top of 4m mast) Vector Instruments anemometer and wind vane, Brookes and Gatehouse anemometer/wind vane, a similar Brookes and Gatehouse instrument was mounted from the ships rail close to the 4m mast.
6. (boom from 4m mast) Vector Instruments aspirated psychrometer
7. Vaisala Humicap humidimeter in stack of plates radiation shield (IOS)
8. Standard + champagne raingauge collectors (IOS/IH)
9. Port Stevenson screen (IOS): Delta-T Devices aspirated psychrometer. A wet and dry bulb psychrometer was mounted by UMIST below this screen.
10. Site of psychrometer readings for WMO observations.
11. E.G.&G. Humidimeter (UMIST)
12. Kipp and Zolen solarimeter (IOS)
13. Eppley pyrgeometer (IOS)
14. Starboard Stevenson screen (IOS): Delta-T Devices aspirated psychrometer, Vaisala Humicap humidimeter, Vaisala radiosonde.
15. Mast with Vector Instruments anemometer and wind vane (UMIST)
16. FSSP and ASASP aerosol probes (UMIST)
17. Radar platform: Hicup instrument, Hicup inlet (legs 2,3,4), Michell humidimeter inlet (legs 2,3,4) and instrument (leg 2 only).
18. (lower arm of upper crosstrees): to starboard: Vector Instruments anemometer and wind vane (IOS); to port: standard and champagne raingauge collectors (IOS/IH).
19. (upper crosstrees): leg 1 only: Hicup inlet, Michell instrument and inlet (UMIST)
20. (Hiab crane jib): SST radiometer (SUDO)
21. Standard and champagne raingauge collectors (IOS/IH)
22. Vaisala radiosonde balloon launcher (IOS/NPS).
23. Site of WMO bucket SST measurements.
24. Vector Instruments anemometer and wind vane (IOS)
25. Soap-on-a-rope trailed thermistor SST sensor (IOS)
26. Site of on-deck SST instrument (IOS)
27. SST fish (IOS)
28. (in main lab) Magnetic compass (IOS)
29. Site of Helium cylinders for radiosonde balloons (IOS/NPS)



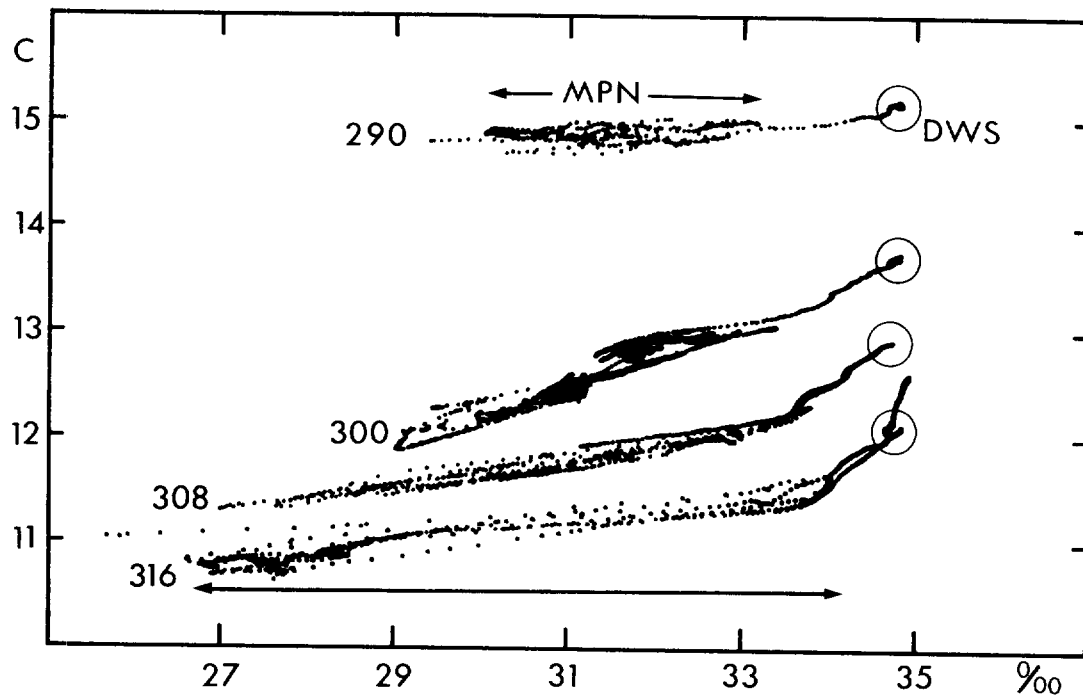
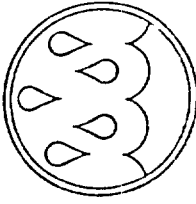

Figure 3. Temperature salinity diagram showing the change in surface water properties between the SST surveys on days 290, 300, 308, and 316. Values representing the DWS are circled, variations in the SST survey area near MPN are marked by arrows for days 290 and 316.

APPENDIX 1.

HEXOS Activity Summary Sheets for the Frederick Russell

HEXMAX summary sheet



HEXOS

Institute IOS / NPS / SUDO

chief scientist position RRS Frederick Russell

~ see text

Julian Day	279	280	281	282	283	284	285
date	monday					11-10-86	12
time (GMT)	6 12 18	6 12 18	6 12 18	6 12 18	6 12 18	6 12 18	6 12 18

Instruments	+	o	+	o	+	o	+	o	+	o	+	o	+	o	+	o	+	o
Ship - near MPN																		
- near DWS																		
IOS - Multimet A																		
- Multimet B																		
IOS/NPS Radiosondes																		
NPS - Hot Film																		
- Lyman-Alpha																		
Minicups																		
SUDO IR Radiometer																		
IOS On-deck CTD																		

narrative GT. YARMOUTH LEG 1

HEXMAX summary sheet

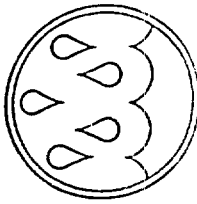

HEXOS

Institute	UMIST
chief scientist	Smith/Park
position	RRS Frederick Russell

Julian Day							284	285
date							11	12
time (GMT)	6 12 18	6 12 18	6 12 18	6 12 18	6 12 18	6 12 18	6 12 18	6 12 18

Instruments								
ASASP	+							
FSSP	o							
OAP	+							
Mitchell	+							
EG&G	+							
HICUP	+							
ff, ddd	+							
T _d , T _w	+							
	+							
	o							

narrative

HEXMAX summary sheet

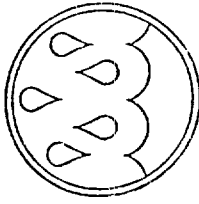

HEXOS

Institute	IOS/NPS/SUDO
chief scientist	- see text
position	RRS Frederick Russell

Julian Day	286	287	288	289	290	291	292
date	monday 13	14	15	16	17	18	19
time (GMT)	6 12 18	6 12 18	6 12 18	6 12 18	6 12 18	6 12 18	6 12 18

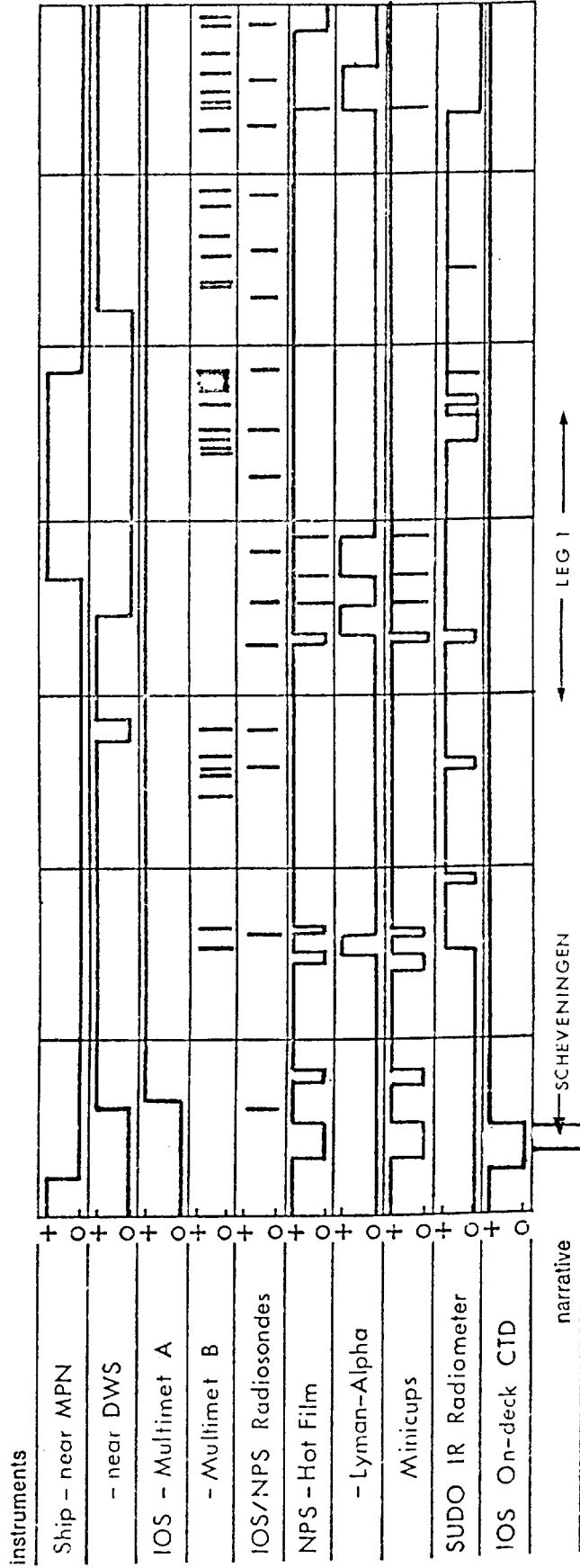

HEXMAX summary sheet

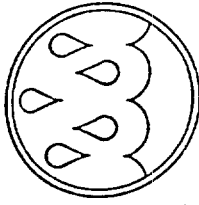

HEXOS

Institute	UMIST
chief scientist	Smith / Park
position	RRS Frederick Russell

Julian Day	286	287	288	289	290	291	292
date	monday 13	14	15	16	17	18	19
time (GMT)	6 12 18	6 12 18	6 12 18	6 12 18	6 12 18	6 12 18	6 12 18

Instruments	+	o	+	o	+	o	+	o	+	o	+	o	+	o	+	o	+	o
ASASP																		
FSSP																		
OAP																		
Mitchell																		
EG & G																		
HICUP																		
ff, ddd																		
T _d , T _w																		
narrative																		

HEXMAX summary sheet

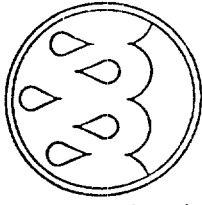

HEXOS

Institute	IOS / NPS / SUDO
chief scientist	- see text
position	RRS Frederick Russell

Julian Day	293	294	295	296	297	298	299
date	monday 20	21	22	23	24	25	26
time (GMT)	6 12 18	6 12 18	6 12 18	6 12 18	6 12 18	6 12 18	6 12 18

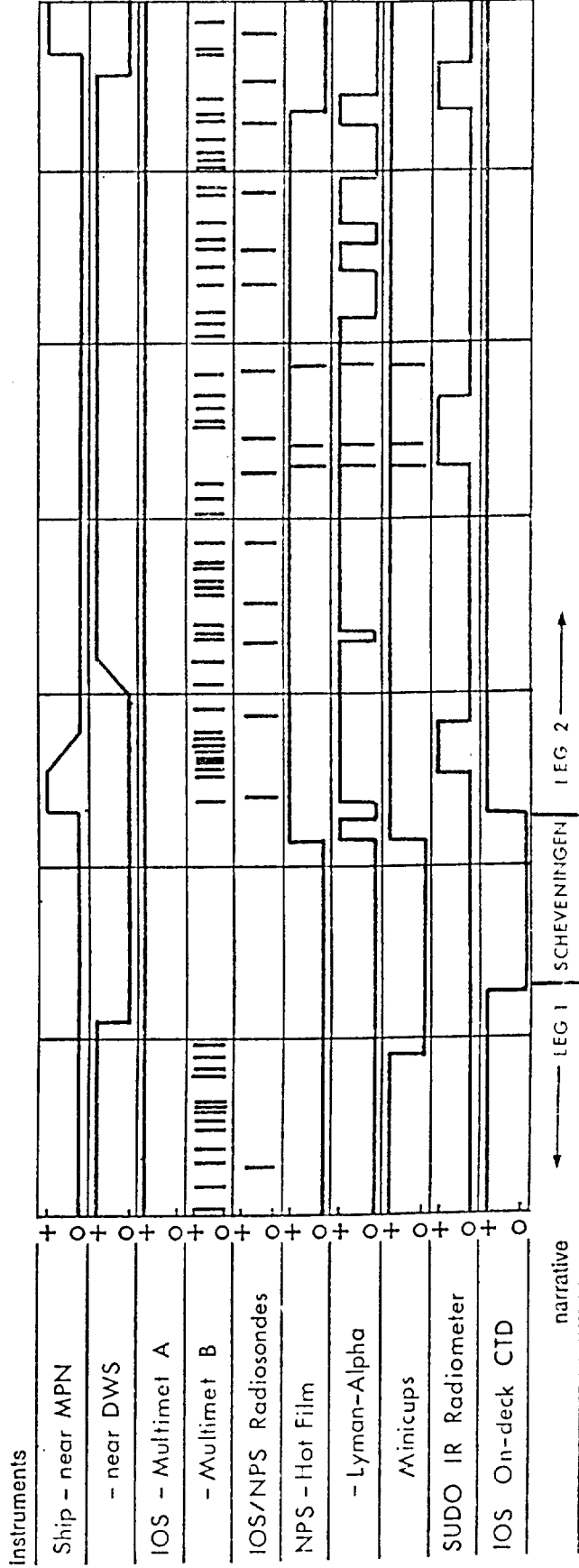

HEXMAX summary sheet

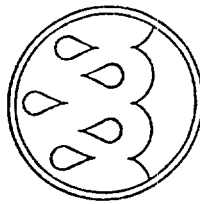

HEXOS

Institute	UMIST
chief scientist	Smith / Park
	position RRS Frederick Russell

Julian Day	293	294	295	296	297	298	299
date	monday 20	21	22	23	24	25	26
time (GMT)	6 12 18	6 12 18	6 12 18	6 12 18	6 12 18	6 12 18	6 12 18

Instruments	293	294	295	296	297	298	299
ASASP	+						
FSSP	+						
OAP	+						
Mitchell	+						
EG & G	+						
HICUP	+						
ff, dtd	+						
T _d , T _w	+						
narrative	+						

HEXMAX summary sheet

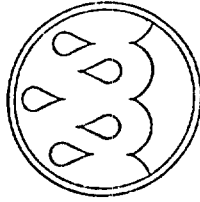

HEXOS

Institute	IOS / NPS / SUDO	
chief scientist	- see text	position RRS Frederick Russell

Julian Day	300	301	302	303	304	305	306
date	monday 27	28	29	30	31	1-11	2
time (GMT)	6 12 18	6 12 18	6 12 18	6 12 18	6 12 18	6 12 18	6 12 18

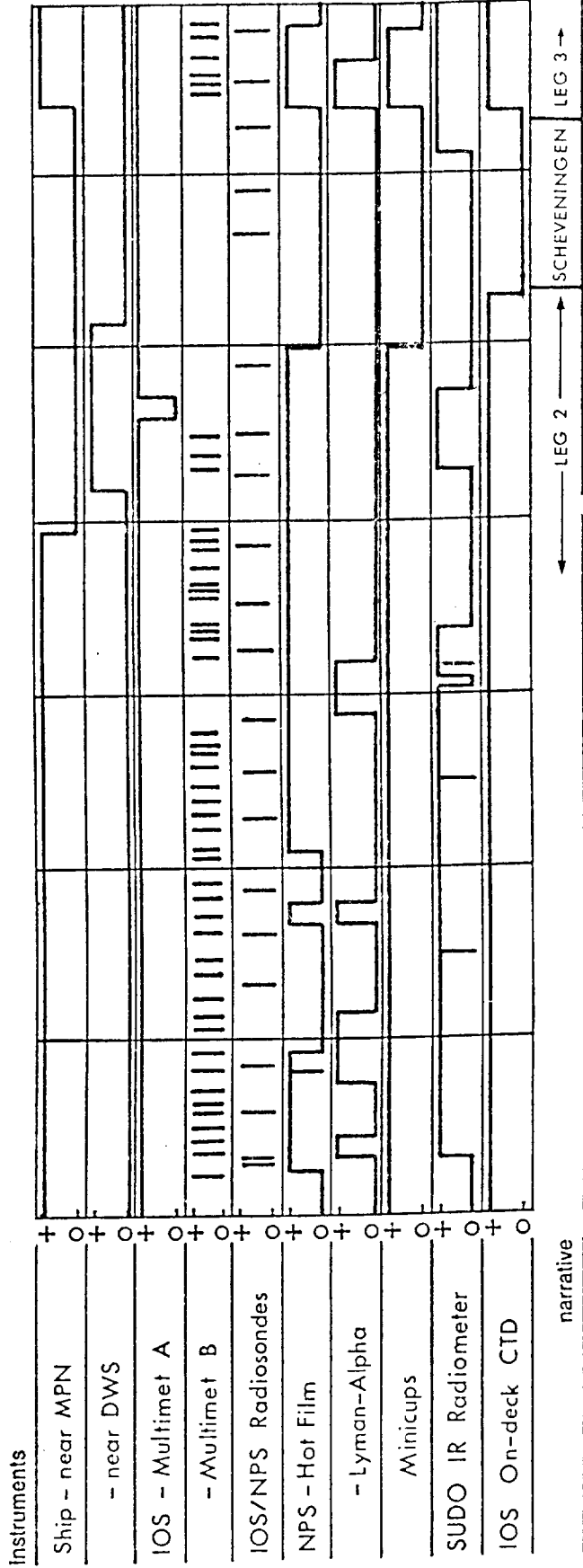

← LEG 2 →

← SCHEVENINGEN LEG 3 →

HEXMAX summary sheet

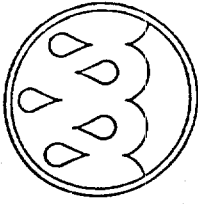

HEXOS

Institute	UMIST	
chief scientist	Smith / Park	position RRS Frederick Russell

Julian Day	300	301	302	303	304	305	306
date	monday 27	28	29	30	31	1-11	2
time (GMT)	6 12 18	6 12 18	6 12 18	6 12 18	6 12 18	6 12 18	6 12 18

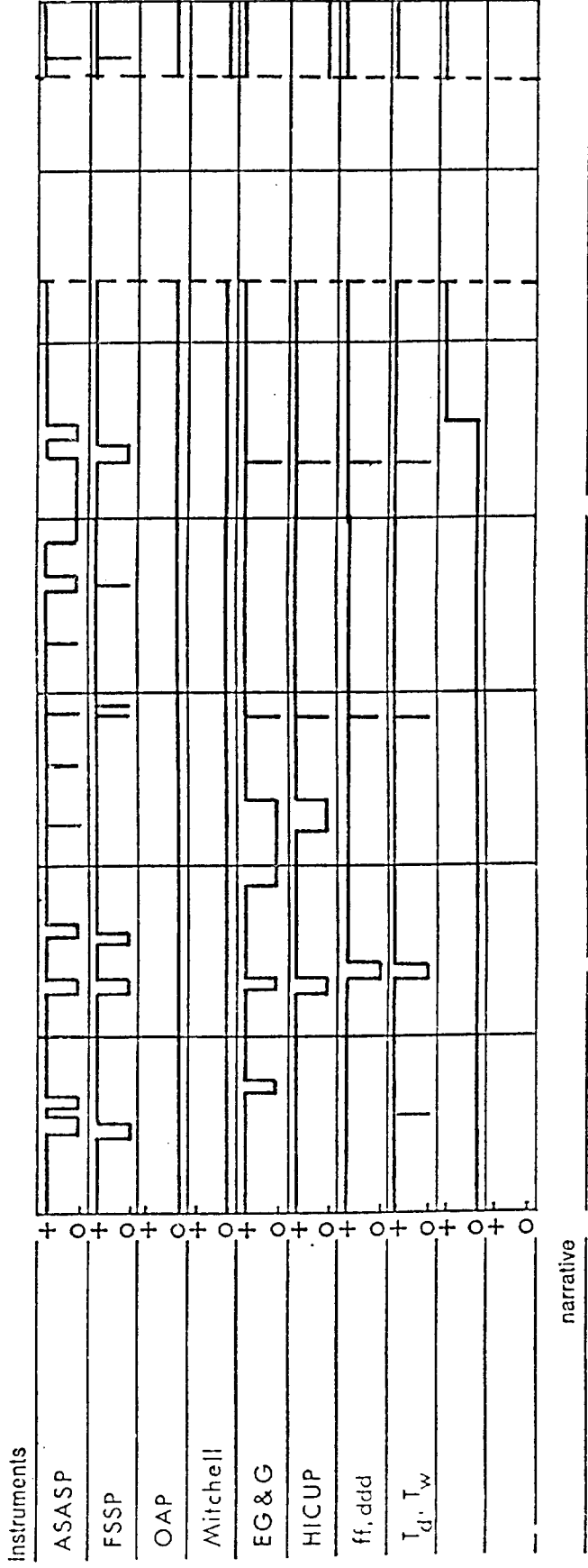

HEXMAX summary sheet

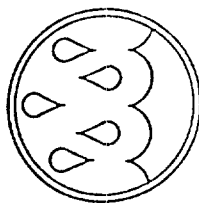

HEXOS

Institute	IOS/NPS/SUDO	
chief scientist	- see text	position RRS Frederick Russell

Julian Day	307	308	309	310	311	312	313
date	monday 3	4	5	6	7	8	9
time (GMT)	6 12 18	6 12 18	6 12 18	6 12 18	6 12 18	6 12 18	6 12 18

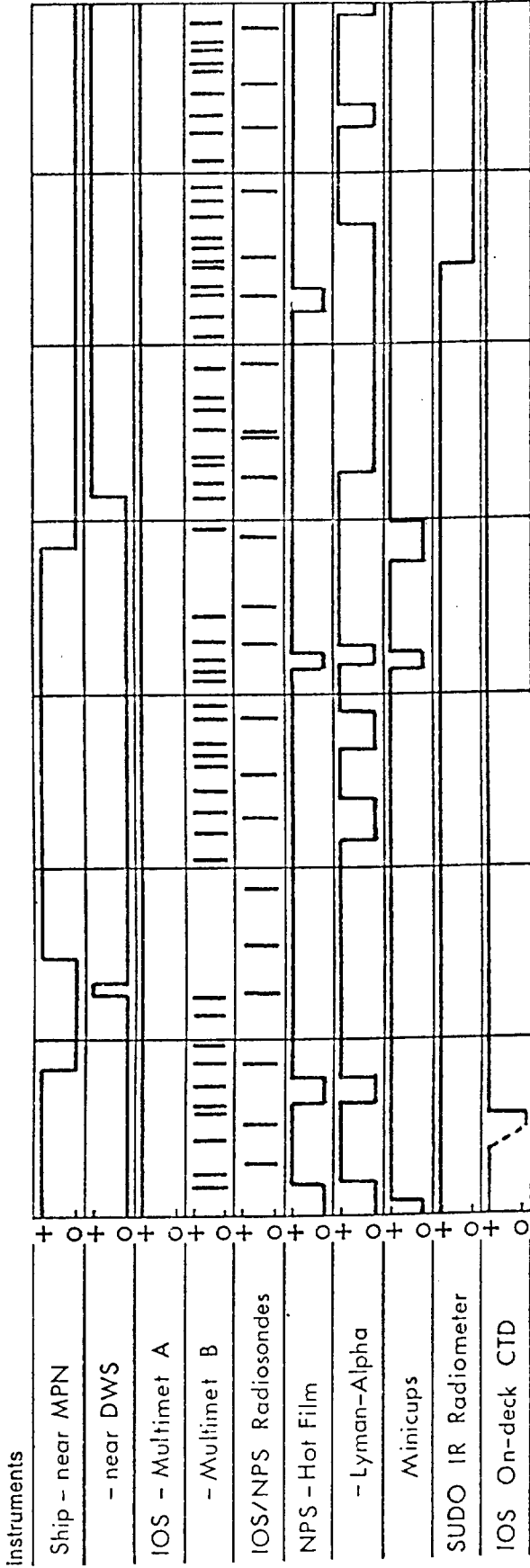

LEG 3

narrative

HEXMAX summary sheet

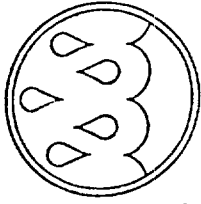

HEXOS

Institute	UMIST
chief scientist	Smith / Park
position	RRS Frederick Russell

Julian Day	307	308	309	310	311	312	313
date	monday 3	4	5	6	7	8	9
time (GMT)	6 12 18	6 12 18	6 12 18	6 12 18	6 12 18	6 12 18	6 12 18

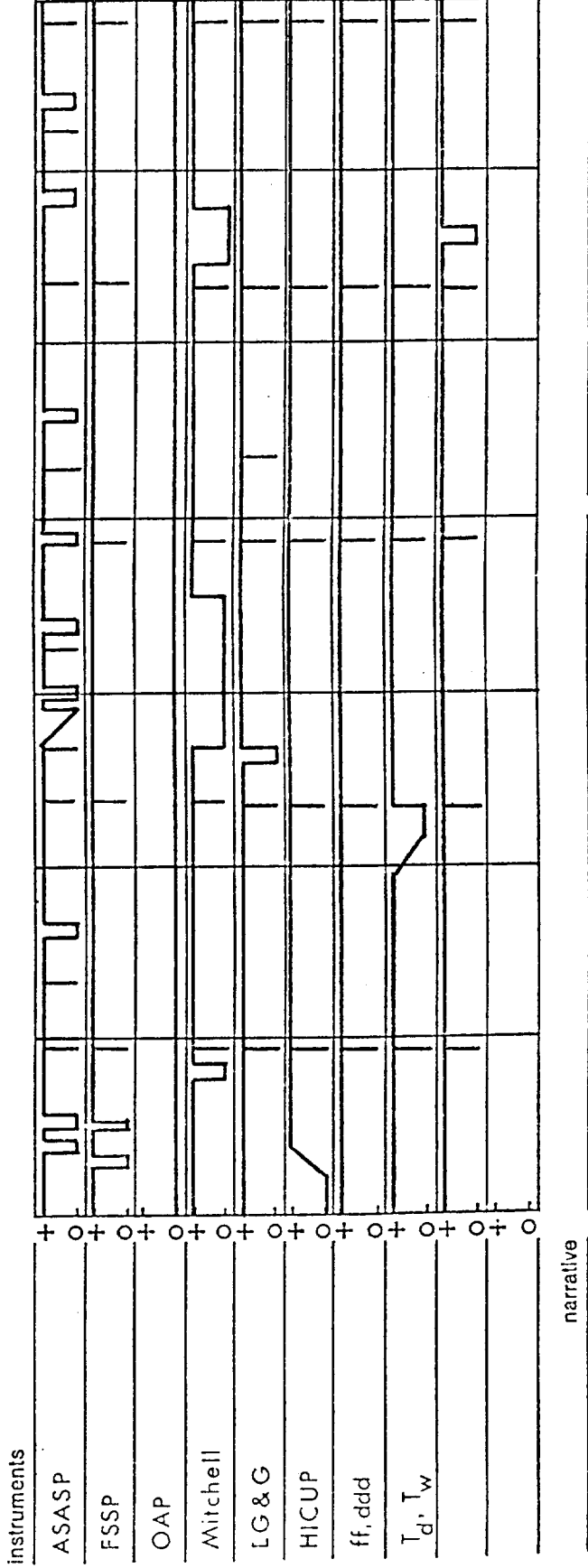

HEXMAX summary sheet

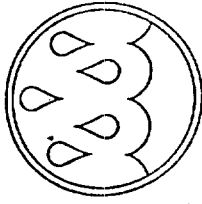

HEXOS

Institute	IOS / NPS / SUDO					
chief scientist	- see text		position		RRS Frederick Russell	

Julian Day	314	315	316	317	318	319	320
date	monday 17	18	19	20	21	22	23
time (GMT)	6 12 18	6 12 18	6 12 18	6 12 18	6 12 18	6 12 18	6 12 18

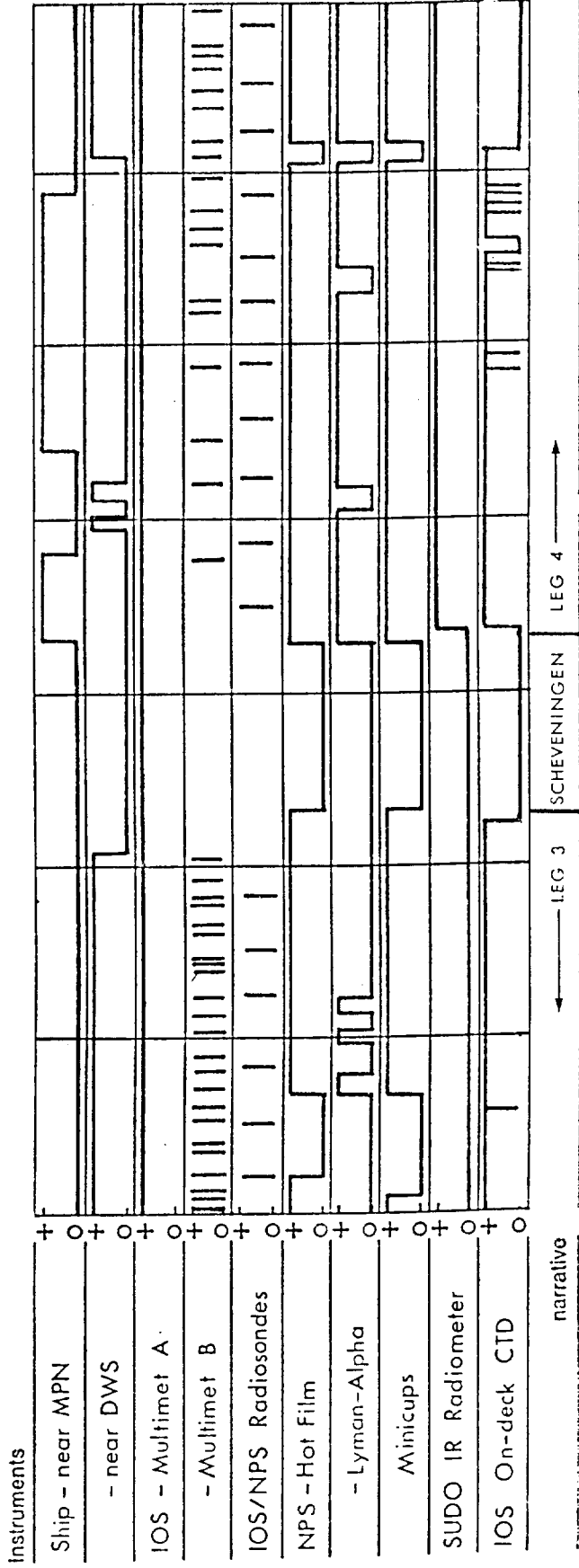

HEXMAX summary sheet

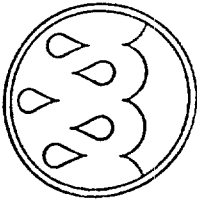

HEXOS

institute	UMIST
chief scientist	Smith / Park
	position RRS Frederick Russell

Julian Day	314	315	316	317	318	319	320
date	monday 10	11	12	13	14	15	16
time (GMT)	6 12 18	6 12 18	6 12 18	6 12 18	6 12 18	6 12 18	6 12 18

instruments	+	o	+	o	+	o	+	o	+	o	+	o	+	o	+	o	+	o
ASASP																		
FSSP																		
OAP																		
Mitchell																		
EG & G																		
HICUP																		
ff, ddd																		
T _d , T _w																		

narrative

HEXMAX summary sheet

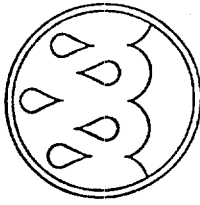

HEXOS

Institute	IOS / NPS / SUDO	
chief scientist	- see text	position RRS Frederick Russell

Julian Day	321	322	323	324	325	326
date	monday 17	18	19	20	21	22
time (GMT)	6 12 18	6 12 18	6 12 18	6 12 18	6 12 18	6 12 18

Instruments

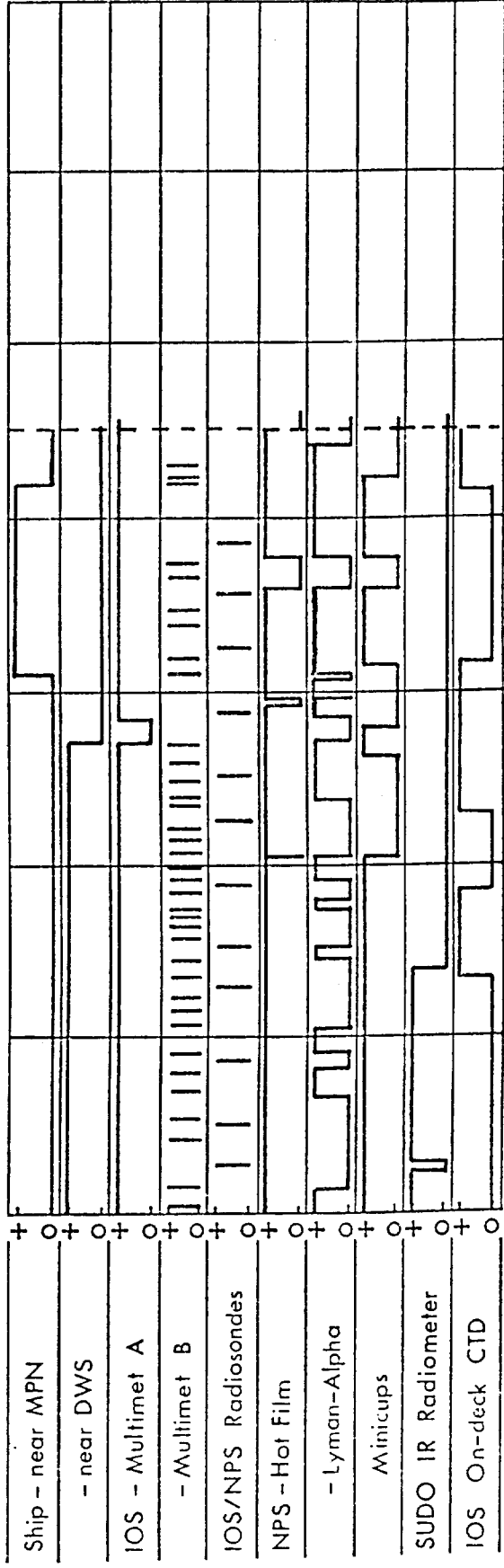

narrative

LEG 4

GT. YARMOUTH

HEXMAX summary sheet

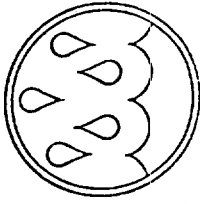

HEXOS

Institute	UMIST
chief scientist	Smith / Park
position	RRS Frederick Russell

Julian Day	321	322	323	324	325	326
date	monday 17	18	19	20	21	22
time (GMT)	6 12 18	6 12 18	6 12 18	6 12 18	6 12 18	6 12 18

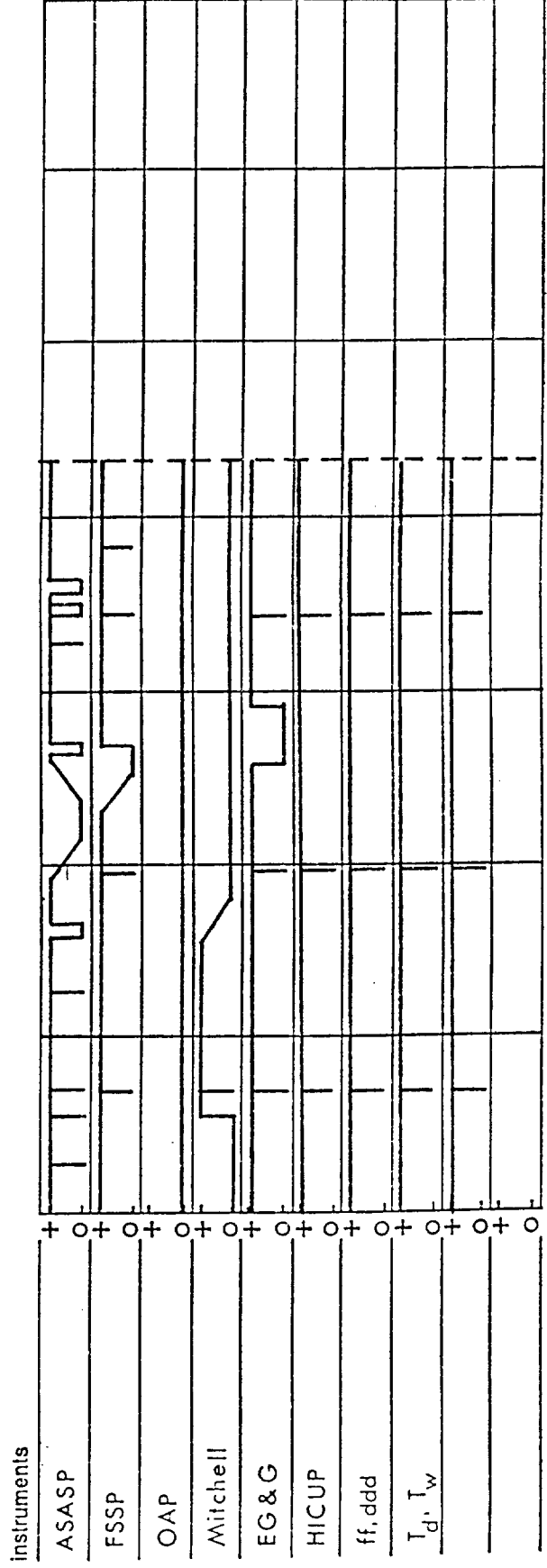

narrative

APPENDIX 2.

List of Radiosonde Ascents

Notes.

1. Due to an error early in the cruise the scientific clock was set to show the day of the year to be one less than the true value. Thus filenames of the form dddtttt, where ddd was the day and tttt the time (gmt), are in error by that amount.
2. The first two radiosonde launches gave no useful data due to a cable fault between the ground receiver and the 403MHz aerial.

<u>Lnch</u>	<u>Day</u>	<u>Time</u>	<u>File</u>	<u>Comments</u>	<u>Lnch</u>	<u>Day</u>	<u>Time</u>	<u>File</u>	<u>Comments</u>
1	285	1646	2841700	No data	35	300	1322	2991330	
2	286	1711	2851700	No data	36	300	1944	2991930	
3	287	1704	2861700		37	301	642	3000645	
4	288	1300	2871300		38	301	1323	3001300	
5	288	1805	2871745		39	301	2018	3002015	
6	289	602	2880600		40	302	641	3010645	
7	289	1202	2881200		41	302	1235	3011230	
8	290	1954	2882000		42	302	1936	3011930	
9	290	630	2890630		43	303	641	3020630	
10	290	1311	2891300		44	303	1218	3021215	
11	290	2005	2892000		45	303	1926	3021915	
12	291	633	2900630		46	304	645	3030645	
13	291	1254	2901230		47	304	1200	3031145	
14	291	2010	2902000		48	304	2036	3032045	
15	292	650	2910630		49	306	1401	3051400	
16	292	1257	2911300		50	306	2046	3052045	
17	292	2028	2912030		51	307	651	3060645	
18	293	630	2920630		52	307	1200	3061200	
19	295	1055	2941100		53	307	1953	3061945	
20	295	2040	2942030		54	308	657	3070645	
21	296	700	2950645		55	308	1200	3071200	
22	296	1203	2951200		56	308	1926	3071930	
23	296	1936	2951930		57	309	631	3080630	
24	297	627	2960630		58	309	1213	3081215	
25	297	1152	2961200		59	309	1953	3081945	
26	297	1913	2961900		60	310	637	3090630	
27	298	703	2970645		61	310	1250	3091250	
28	298	1221	2971215		62	310	2053	3092045	
29	298	2015	2972015		63	311	638	3100645	
30	299	645	2980645		64	311	1200	3101155	
31	299	1249	2981245		65	311	1928	3101930	
32	299	1954	2982000		66	312	630	3110630	
33	300	644	2990645	Hit sea	67	312	1215	3111215	
34	300	700	2990700		68	312	2017	3112015	

<u>Lnch</u>	<u>Day</u>	<u>Time</u>	<u>File</u>	<u>Comments</u>	<u>Lnch</u>	<u>Day</u>	<u>Time</u>	<u>File</u>	<u>Comments</u>
69	313	632	3120630		86	319	2004	3182000	
70	313	1220	3121222	Hit sea	87	320	632	3190630	Not recorded
71	313	1245	3121245		88	320	1030	3191030	
72	313	2021	3122014		89	320	1955	3191945	
73	314	645	3130645		90	321	638	3200630	
74	314	1205	3131205		91	321	1203	3201157	
75	314	2047	3132045		92	321	2025	3202015	
76	315	642	3140630		93	322	624	3210630	
77	315	1215	3141215		94	322	1210	3211200	
78	315	1950	3141945		95	322	2038	3210645	
79	317	1214	3161215		96	323	645	3220645	
80	317	1950	3161945		97	323	1225	3221225	
81	318	638	3170645		98	323	2002	3222000	
82	318	1353	3171335		99	324	630	3230630	
83	318	2010	3172000		100	324	1303	3231300	
84	319	648	3180645		101	324	1910	3231900	
85	319	1218	3181230						