

Intelligent Legged Climbing Service Robot For Remote Inspection And Maintenance In Hazardous Environments

B.L. Luk¹, D.S. Cooke², A.A. Collie², N.D. Hewer², S. Chen³

¹ Centre for Intelligent Design, Automation and Manufacturing (CIDAM),
City University of Hong Kong, Tat Chee Avenue, Kowloon, Hong Kong

² PORTECH Ltd, 15 The Tanneries, Portsmouth, UK

³ Department of Electronics and Computer Science,
University of Southampton, Southampton, UK

E-mail: mebluk@cityu.edu.hk

Abstract-- Wheeled-tracked vehicles are undoubtedly the most popular means of transportation. However, these vehicles are mainly suitable for relatively flat terrain. Legged vehicles, on the other hand, have the potential to handle wide variety of terrain. Robug IIs is a legged climbing robot designed to work in relatively unstructured and rough terrain. It has the capability of walking, climbing vertical surfaces and performing autonomous floor to wall transfer. The sensing technique used in Robug IIs is mainly tactile sensing. A set of reflexive rules have been developed for the robot to react to the uncertainty of the working environment. The robot also has the intelligence to seek and verify its own foot-holds. It is envisage that the main application of robot is for remote inspection and maintenance in hazardous environments.

Index terms-- Legged robot, climbing service robot, insect inspired robot, pneumatic control.

I. INTRODUCTION

Wheeled-tracked vehicles are undoubtedly the most popular means of land-based transportation. However, this kind of vehicles are mainly suitable for relatively flat terrain. Legged vehicles, on the other hand, have the potential to handle wide variety of terrain. Also, they can be designed to negotiate and step over obstacles, climb walls and transfer between planar surfaces. Based on experience from the previous research projects [1][2][3][4], many buildings such as nuclear reactor pressure vessels have very limited access. A mobile robot which has the capability of walking through a service entrance and then transferring itself onto the vertical surface of the inspected building can save time and reduce risk to human workers who may have to launch the mobile robot in difficult circumstances.

Robug IIs was designed to address the above problem, it has the ability to walk from the floor to the wall. It is also capable of climbing over obstacles and has the intelligence to seek and verify foot-holds. This allows the robot to work in relatively unstructured environments.

This paper gives a brief description of Robug IIs' system. The rest of the paper will concentrate on describing the movements and the behaviours used by Robug IIs for wall climbing, climbing over obstacles and floor to wall transfer

II. MECHANICAL SYSTEM

Robug IIs is an articulated leg robot which is powered by pneumatic cylinders. The robot adopted the endoskeletal structure; an internal frame was used to provide the required strength and stiffness for locomotion as well as locations for the joints, whilst the external actuators act as the prime mover. The advantage of using this structure is that it is more practical for fabrication and maintenance.

The robot consists of two similar modules. Each module has 2 mechanical legs and each has a vacuum gripper foot for climbing vertical surfaces. The robot also has three vacuum suckers on its underside. The two modules are joined by a pivot to form a thoraxial joint with a pneumatic cylinder to bend the body. The arrangement increases the effective moving angles of the legs and reduces the stress exerted on the leg-joints (see figure 1). This gives the robot the amount of flexibility required for the floor-to-wall transfer.

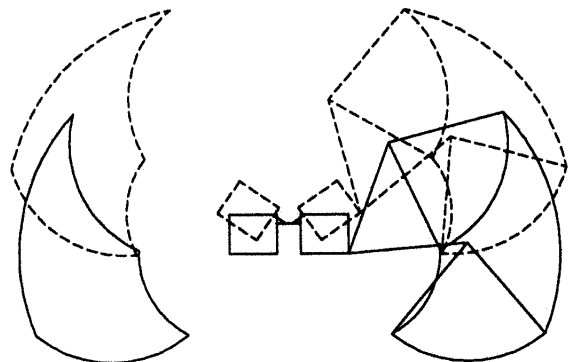

Figure 1. Robug IIs workspace

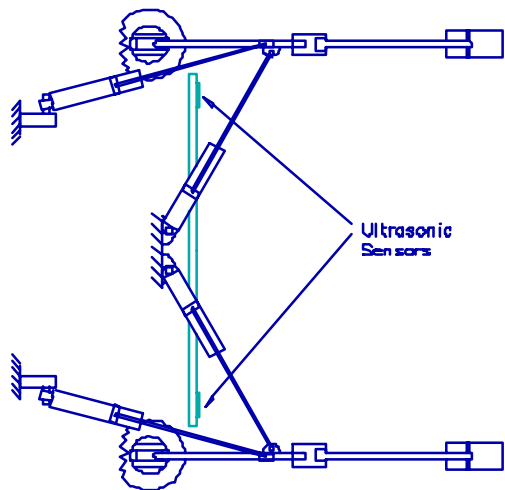

Figure 2. Plan View of the structure of the two front legs

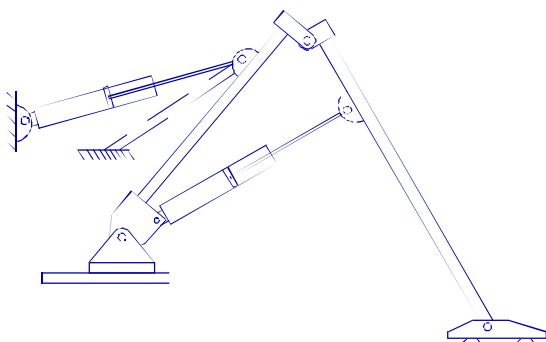

Figure 3. Elevation view of the leg structure

Each leg has three degrees of freedom and is organised as a spider-like structure (see fig 2 and 3). This leg mechanism provides the ability to negotiate and climb over obstacles. It also has the advantage of keeping the body close to the surface which increases the stability of the robot. An open three bar linkage mechanical structure was used to provide all three degrees of movement of each leg. The anchorage points of the hip and abductor cylinders, and the hip joint are widely separated to reduce stresses on the chassis.

The gripper foot is attached to the leg by a ball joint, this provides the gripper foot with the flexibility required to align itself with uneven surfaces. These gripper feet and the base suckers are driven by compressed-air ejector pump and can provide a pull-off force corresponding to 80% atmospheric pressure.

III. CONTROL SYSTEM

Each leg is controlled by an on-board dedicated microcontroller board. These controller boards provide both position, force and compliant control modes. An additional board is used to provide sensor information from the robot. A supervisory computer at the user end provides the human-machine interface, path planning and functions necessary for co-ordinated motion. A master-slave configuration (see Figure 4) via a serial link is used to network the supervisory computer and all the leg controllers. A specially designed protocol is used for passing commands and information between the

Supervisory computer and the robot. All the important commands are arranged as absolute commands. The repetition of the same command does not affect the final movement.

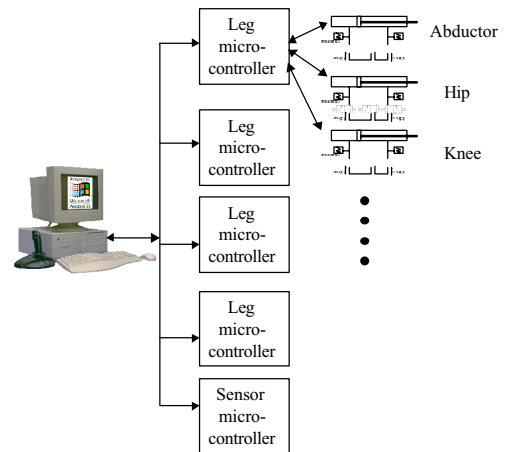

Figure 4. Computer control system

Each cylinder is controlled by three electrically controlled valves (see Figure 5). Pulse Width Modulation method is used to drive the cylinder. In order to allow the robot to negotiate obstacles, each cylinder can be controlled in position mode, force mode and compliant mode. The demand pressure of the cylinder is calculated by multiplying the position/velocity errors with a stiffness coefficient plus the additional force demand (see Equ 1). By adjusting the stiffness coefficient and the additional force demand, compliant control can be achieved.

$$\psi = K_1 \cdot e + K_2 \cdot \dot{e} + K_3 F_d \quad \text{Equ (1)}$$

ψ is the demanded pressure

K_1, K_2, K_3 are constant coefficients

F_d is the forcedemand

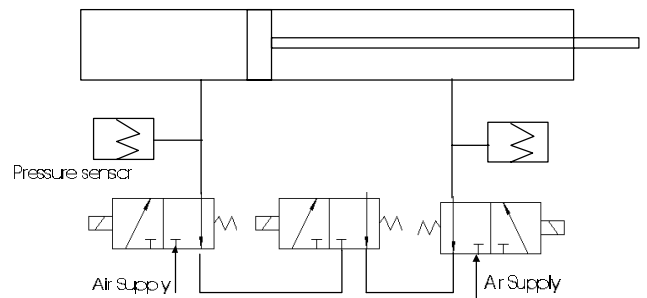

Figure 5. The valve arrangement for cylinder control

IV. BEHAVIOURS

Robug IIs is designed to work in relatively unstructured environment. In order to accommodate the uncertainty in the working environment, Robug IIs is designed as a sensor based control robot rather than a position control robot. The sensing technique used in Robug IIs is mainly tactile sensing. Each leg is equipped with pressure sensors and potentiometers to provide force and position information of the leg. The leg can be used to feel for obstacles and the level of the surface. The compliant control of the leg allows the robot to perform tactile sensing without damaging the building structure. The

vacuum sensors at the feet and base suckers give the measurements of gripping force on the surface. Ultrasonic sensors are also installed at the front of the robot for measuring distance of the object.

In order to allow the robot to handle the uncertainty in unstructured environments, a set of rules has been developed to define the behaviours of the robot for reacting to the sensory information fed back from the environment.

These rules are listed as follow:

1. No leg will move unless the robot has at least 3 suckers gripping firmly on the surface. This rule prevents the robot from falling when it is climbing a wall.
2. A reflex action for searching foothold is build into the leg controller (see Figure 6). This arrangement provides a fast searching movement. The reflex action allows the leg to search for a foot hold in front. It also provides an oscillating movement, which can be used to remove loose material on the surface. This facility will increase the chance of finding gripping surface.

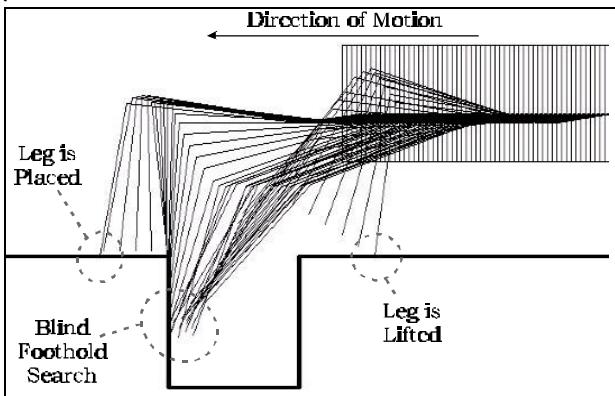

Figure 6. Blind foothold search and obstacle avoidance

3. No two legs will be allowed to apply force in the opposite directions. This prevents any damage to the chassis caused by excessive force since each cylinder can exert 500N force.
4. Always use minimum force for searching foothold and negotiating object. This rule ensures the robot will not cause any damage to the climbing structure.
5. Since the robot is capable of walking, climbing and floor-to-wall transfer, the gravity force exerted on each joint can vary significantly when the robot is lifting the body. A simple compensation scheme is used to overcome the gravity force where additional pressure can be added gradually by increasing the additional force demand variable in the leg controller.
6. The robot will adjust the position of the legs to spread out the force exerted on each leg.

The above rules form the basic behaviours of the robot. They provide the local autonomy to each limb. Other high level of strategies can be added to provide the task oriented applications.

V. WALKING AND CLIMBING MOVEMENT

The movement of the robot can be grouped into two main types: 1) normal climbing or walking, 2) climbing over obstacle or floor to wall transfer.

During the normal climbing or walking, the thoraxial actuator will be fully extended so that the two mechanical modules are level with each other. Base suckers are used to assist climbing and walking. In this mode, the movement of the robot can be divided into 4 basic steps: 1) move the legs to follow a pre-planned trajectory, 2) get the legs to grip onto the surface, 3) move the body to follow a pre-planned trajectory and 4) get the base vacuum sucker to grip onto the surface. When the base suckers are firmly attached on the wall, all four legs can move at the same time for fast operation.

Considering the case when the robot is moving forward, the following movements are implemented :

1. The robot starts at the rest position as shown in Figure 7.
2. The robot releases all the gripper feet suckers.
3. All four legs will follow a pre-defined trajectory (see Figure 8).
4. Each leg starts searching for a gripping surfaces until a secure grip is verified. The attitude after gripping on the surface is shown in figure 9.
5. The robot then releases its belly sucker and levers its body up and follows a pre-planned trajectory as shown in figure 10.
6. The robot starts searching for a gripping surface until a secure grip is verified at the base suckers. The position after the body gripping on the surface is shown in figure 11.

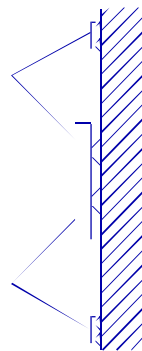

Figure 7

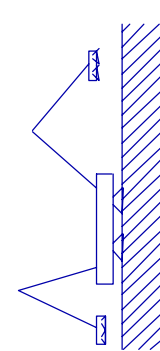

Figure 8

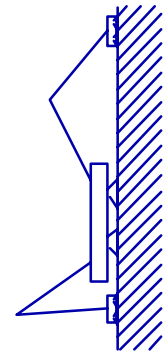

Figure 9

In the case of turning, the front leg on the near side of the turning direction and the rear leg on the off side will move outward. The remaining legs will move inward. The robot will then lift the body and turn to the required direction.

For climbing obstacles or floor-to-wall transfer motions, the robot will use its thoraxial actuator to control the bending angle of the body. This increases the effective angle that the leg can travel and hence enhanced the flexibility of the robot for climbing over sharp angled objects or slopes. The base suckers are not normally used in this kind of movement and only one leg is moving at any one time.

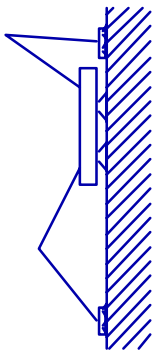

Figure 10

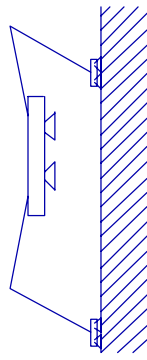

Figure 11

When the robot is performing a floor-to-wall transfer operation, a sequence of movements is executed as follow:

1. The robot will walk toward the wall until a full walking pace is not possible. Ultrasonic distance sensors are used to measure the distance. The robot will walk with its front legs spread when it is close to the wall.
2. The robot releases the front feet and front base sucker. It then bends the body up according to slope of the wall.
3. The front legs starts searching for a secure grip on the wall (see figure 12).
4. The robot then releases its rear base sucker and then lift its body up (see figure 13).
5. Each leg will release its gripper feet sucker and search for a secure grip in turn.
6. It lifts its body up and follows a planned trajectory (see figure 14).
7. Step 5 and 6 are repeated until the rear legs are just reaching the floor.
8. The robot will straighten the spine cylinder and the move its body toward the wall until a secure grip is obtained at the base suckers.
9. It then move its rear legs in a high gait to transfer onto the wall.

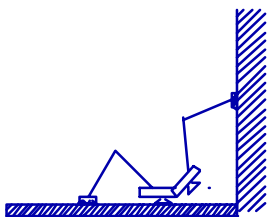

Figure 12

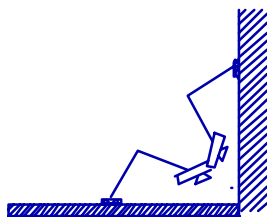

Figure 13

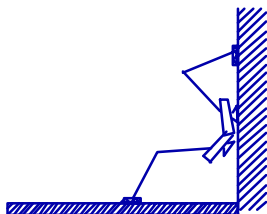

Figure 14

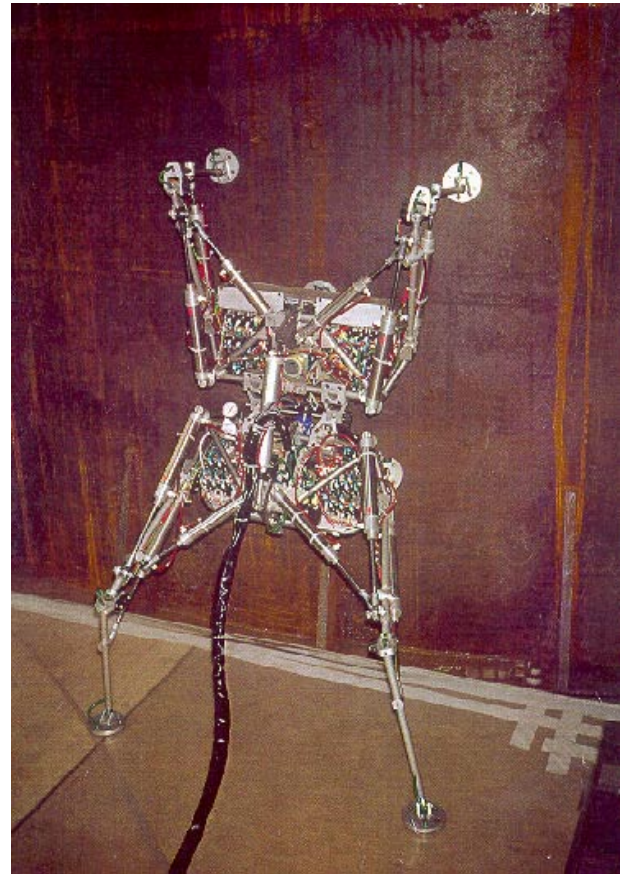

Figure 15. Robug IIs was performing an automatic floor-to-wall transfer.

VI. CONCLUSIONS

Robug IIs with its insect-like structure and articulated limbs has the mechanical capability to handle wide variety of the terrain. The reflexive behaviours implemented on the robot allow it to work in relatively unstructured environment. This kind of autonomy has certainly simplified the operation procedures of the robot. The capability of performing automatic floor-to-wall transfer is vital for applications where access to the structure being inspected is limited. The robot has been tested on a real-scale model of a Magnox nuclear reactor pressure vessel and the result has confirmed the usefulness of the robot (see Figure 16).

Further work in navigation system is being carried out to enhance the autonomy of the robot. Since the robot is capable of walking and climbing, the navigation problem is no longer restricted in 2-D space. The robot has to determine whether it should walk round the obstacles or climb over them.

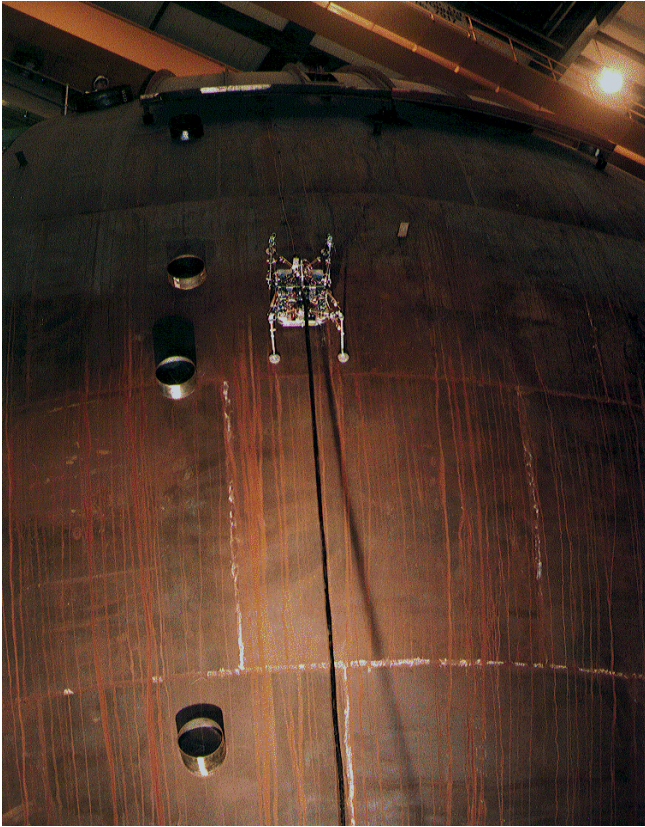

Figure 16. Robug IIs was climbing a Magnox nuclear reactor pressure vessel

VII. REFERENCES

- [1] M.S. Burrows, A.A. Collie and A. Curry , "Inspection Of A Nuclear Reactor Pressure Vessel By Vacuum Attached And Magnetically Attached Mobile Robots", 4th International Symposium on Offshore, Robotics and Artificial Intelligence - Telerobotics In Hostile Environments, 11-12 December 1991, Marseille, France.
- [2] A.A. Collie, J. Billingsley and L. Hatley, "The Development of a Pneumatically Powered Walking Robot Base", C377/86 IMechE, pp 137- 144.
- [3] B.L. Luk, A.A. Collie and T.S. White, "NERO- A teleoperated wall climbing vehicle for assisting inspection of a nuclear reactor pressure vessel", 13th ASME International Computers in Engineering Conference and Exposition, 8-12 August 1993, San Diego, USA.
- [4] N.R. Bevan, A.A. Collie, T.S. White, B.L. Luk, "A robotic manipulator for inspection and maintenance of tall structures", Symposium of Automation and Robotics in Construction, 24-26 May 1994, Brighton, UK.