

Energy-Neutral Solar-Powered Street Lighting with Predictive and Adaptive Behaviour

Sei Ping Lau, Alex S. Weddell, Geoff V. Merrett, Neil M. White
Electronics and Computer Science
University of Southampton, UK

{spl1g11, asw, gvm, nmw}@ecs.soton.ac.uk

Abstract

Street lighting can enhance the safety and security of residential and commercial areas. However, its installation and operation is expensive: cables must be installed, and power is drawn from the grid which is typically dominated by non-renewable sources. A potential solution is the use of solar energy to power individual street lights locally. However, with limited energy storage and variable solar availability, existing lighting control strategies are unsuitable for this application. This paper describes the extension of an existing grid-powered street light management scheme, which responds to vehicles and pedestrians by dynamically changing the brightness of street lights in their vicinity, setting an optimal pattern of lighting. The proposed scheme, TALiSMaN-Green, achieves energy-neutral solar-powered operation. It maintains a consistent level of usefulness of street lights across a complete overnight period, regardless of the amount of energy stored at the beginning of the night. Unlike existing schemes, which may run out of energy during the night, it learns the dynamics of traffic volumes and sunrise times and budgets energy accordingly.

Categories and Subject Descriptors

C.2.4 [Computer-Communication Networks]: Distributed Systems-Distributed applications

Keywords

Energy prediction, energy-neutral street lighting

1 Introduction

The world's 90 million street lights consume 106 TWh annually, leading to the emission of 76 million tonnes of CO₂ [1]. In addition, the number of installed street lights is expected to increase by over 300% in the coming decade [2]. Street lighting has been shown to reduce crime and traffic collisions [3, 4]; however, with approximately 40% of a city's municipal electricity budget spent on street lighting,

and with continuously-rising electricity costs [5], sustaining street light operation has become important. Efforts to reduce the energy demands of street lighting have focussed on two aspects: replacement of each street light's luminaire, and its switching mechanism.

The replacement of end-of-life street lights with newer and more energy efficient luminaires has delivered significant energy savings. For example, in Thailand, a 25-30% energy saving was achieved with a new high pressure sodium (HPS)-based luminaire [6]. Recent developments in light-emitting diode (LED)-based luminaires have resulted in them being used instead, as they offer a further 25% power reduction and deliver light instantly when switched on [7, 8].

Conventionally, the switching mechanism of the street light is realised by a pre-set clock, or an integrated light sensor relay. Once switched on, street lights remain lit continually throughout the night. However, this mode of operation incurs significant energy wastage, especially when roads are only intermittently used and lighting at full brightness is not necessary. Thus, the use of time-based dimming approaches has been adopted by many local governments, selectively reducing the brightness of street lights during the early hours when low traffic volumes are expected. Operating street lights on this basis can reduce energy consumption by over 20% [9]. Most recently, research into smart electronics to control street lights has attracted much attention. Generally, this includes the use of long- and/or short-range wireless communication networks [10], sensors [11], and artificial intelligence [12] for the remote management and monitoring of street light operation.

While most of these approaches have focused on improving the energy-efficiency of 'grid-powered' street lights, their application to 'off-grid' street lights (powered locally by renewable energy) is restricted. This is because energy harvested from solar [13] or wind [14] fundamentally varies due to weather conditions, whereas grid-powered street lights have a reliable electricity supply to sustain their daily operation. Furthermore, off-grid street lights also store energy in batteries that have a restricted capacity, which limits the amount of energy can be harvested from these sources. Off-grid street lights are most useful in remote and isolated places, such as rural villages and isolated islands, where access to the grid is limited. As part of an effort to reduce electricity loads during peak hours, it has also been proposed that these could replace grid-powered street lights [15].

Permission to make digital or hard copies of all or part of this work for personal or classroom use is granted without fee provided that copies are not made or distributed for profit or commercial advantage and that copies bear this notice and the full citation on the first page. Copyrights for components of this work owned by others than ACM must be honored. Abstracting with credit is permitted. To copy otherwise, or republish, to post on servers or to redistribute to lists, requires prior specific permission and/or a fee. Request permissions from Permissions@acm.org.

ENSSys'14, November 6, 2014, Memphis, TN, USA
Copyright 2014 ACM 978-1-4503-3189-0/14/11...\$15.00
<http://dx.doi.org/10.1145/2675683.2675690>

Although a multi-sensor system [16] can prolong the operational hours of off-grid street lights by reducing their average power consumption by 40%, it is unable to budget energy to ensure that they can continue operating across the entire night. This means that the light may, for example, operate normally until the middle of the night, but run out of energy and be completely inoperable in the early morning. Schemes which save energy through arbitrarily reducing brightness [17, 18] have neglected the associated impact on the usefulness of street lights to pedestrians and motorists.

In our previous work [19], we demonstrated that an adaptive street lighting scheme, known as **Traffic-Aware Street Lighting Scheme Management Network (TALiSMaN)**, can substantially improve the energy efficiency of state-of-the-art lighting schemes while maintaining their usefulness to road users. That scheme used sensor nodes mounted on street lights to detect passing pedestrians and motorists. It turned street lights on in the optimal pattern of brightness to deliver maximum usefulness to the road users, while still conserving substantial energy. This was an advancement over state-of-the-art adaptive schemes, which naively set all street lights in the vicinity of road users to maximum brightness.

In this paper, we extend TALiSMaN to address the shortcomings of existing off-grid street lights. The novelty of this enhancement is to use an energy demand predictor to ensure that a limited energy budget can be used fairly across the complete night so that the street light is just as useful in the early morning as it was the previous evening. This new scheme is known as **TALiSMaN-Green**. It is facilitated by a machine learning algorithm and an autonomous wireless sensor network (WSN). The performance of the proposed scheme is evaluated and compared using a linear street light topology. Based on the simulation results, we show that TALiSMaN-Green maintains the operation and usefulness of a network of solar-powered street lights across a complete night, even with a highly constrained energy budget.

2 TALiSMaN

Before detailing the proposed TALiSMaN-Green street light control scheme, we first give a brief overview of the functionality of TALiSMaN [19]. The aim of this scheme is to set lighting conditions optimally to satisfy different road users' needs. This improves their ability to navigate, to avoid potential obstacles, and to feel secure while they travel around at night. TALiSMaN uses sensors to detect the presence of pedestrians and motorists, and sets the brightness of street lights in the vicinity to deliver this optimal light distribution, as illustrated in Figure 1. The figure illustrates the condition where a motorist or pedestrian is detected at street light s_1 . For pedestrians, the brightness of street lights decreases as a function of distance from the pedestrian; conversely, for the motorist, all street lights within 100 m are turned on at full brightness. This was defined to deliver maximum usefulness to road users, based on the literature.

When a street light detects a road user, it relays this information to nearby street lights. Their brightness is adjusted according to their approximate distance, d_{approx} , from the first street light. This communication is facilitated by a multi-hop WSN. After this presence information is shared amongst the

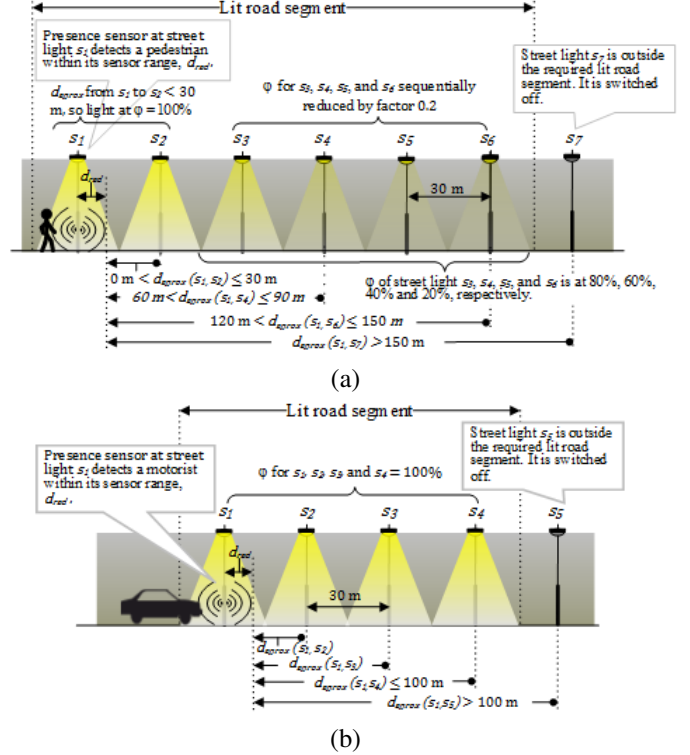

Figure 1. Optimum lighting conditions for (a) a pedestrian and (b) a motorist, delivered by TALiSMaN [19].

street lights, the brightness of the respective street lights, ϕ is progressively adjusted based on the distance from the street light that detected the road user, and the lighting pattern that is required.

The energy, $E(M)$, consumed by a street light after M discrete timesteps is given by [19]:

$$E(M) = \sum_{m=0}^M P_{max} \phi T \quad (1)$$

where ϕ is the brightness of the street light relative to full power (%), P_{max} is the maximum power rating of the luminaires (W), and T is the duration of a single timestep m . For example, when $\phi = 80\%$, the street light's energy consumption is also reduced to 80% of P_{max} .

3 The Architecture of TALiSMaN-Green

The proposed TALiSMaN-Green scheme is illustrated in Figure 2. The aim of this scheme is to deliver a consistent usefulness of street lighting across a whole night, even if the stored energy is less than would be required by TALiSMaN. It incorporates a TALiSMaN module, which monitors the presence of pedestrians and motorists and requests a certain light brightness, ϕ , as described in previous section. The additional functionality of TALiSMaN-Green includes a Sunrise Time Estimation module, which estimates the time when the light will be turned completely off, and a Prediction Algorithm which predicts TALiSMaN's overall energy demand until sunrise. This, along with information on the amount of energy stored, allows the requested brightness of

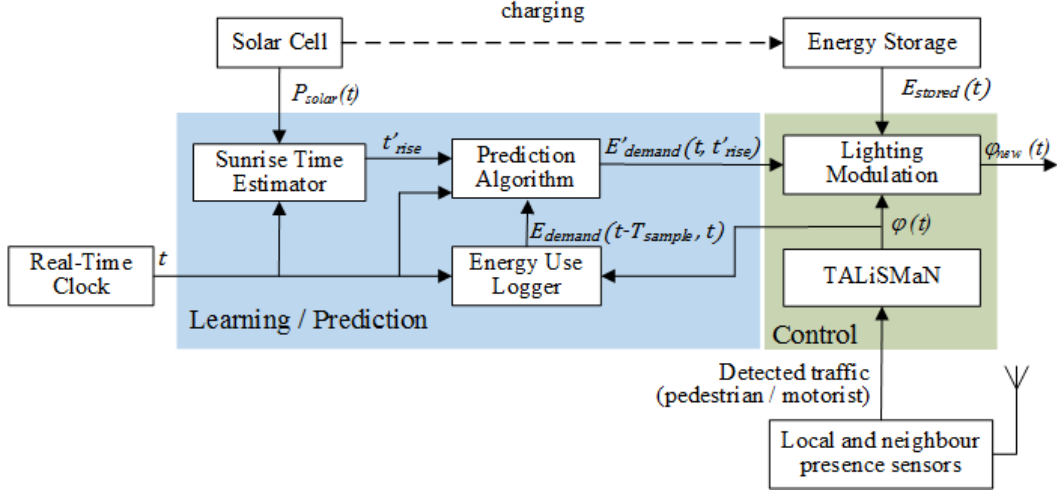

Figure 2. System overview of TALiSMaN-Green.

the street light, ϕ , to be modulated as necessary to conserve energy. To enable TALiSMaN-Green to learn and then predict the energy required by TALiSMaN until sunrise, it uses historical data on energy use. This is provided by the Energy Use Logger, which collates data on the energy required by TALiSMaN over a time interval, using its requested ϕ values. In short, these additional functions require:

- Prediction of energy demand until sunrise, E'_{demand} , to deliver the brightness levels requested by TALiSMaN.
- Knowledge of the current time, t .
- Prediction of the time of next sunrise, t'_{rise} .
- Estimation of the remaining energy, E_{stored} , in the energy storage device (e.g. battery).

The following subsections detail the proposed approach to meet these requirements.

3.1 Energy Demand Prediction Algorithm

The system must be able to predict the expected energy demand, E'_{demand} , of TALiSMaN until sunrise. Owing to the resource-constrained nature of this energy-harvesting system, the proposed prediction algorithm uses an Exponentially Weighted Moving Average (EWMA). This algorithm is renowned for delivering reasonable prediction accuracy while imposing a relatively low demand for memory and computational resources [20].

To predict E'_{demand} , a day is divided into N equal sized timeslots. At each timeslot, the energy required by TALiSMaN for optimum lighting conditions, E_{cons} , is recorded and then is used to predict the energy required in future timeslots, E'_{cons} . As an example, at the present timeslot n , the energy demand prediction is shown shaded in Figure 3. To predict the E'_{demand} for timeslot $n+1$ requires summation of E'_{cons} terms. E'_{cons} is predicted by EWMA that uses a combination of $E_{cons}(n)$ and the mean energy needed at timeslot $n+1$ for the past D days, $\mu_D(d, n+1)$. Therefore, E'_{demand} is given by:

$$E'_{demand}(d, n+1) = \sum_{i=n+1}^N E'_{cons}(d, i) \quad (2)$$

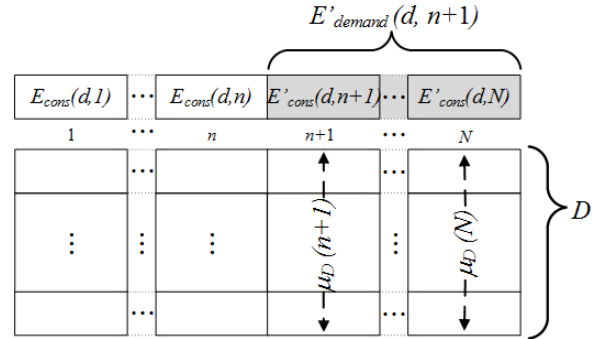

Figure 3. Graphical representation of energy demand prediction (adapted from [20]).

$$E'_{cons}(d, n) = \alpha E_{cons}(d, n-1) + (1-\alpha)\mu_D(d, n) \quad (3)$$

$$\mu_D(d, n) = \frac{1}{D} \sum_{i=d-1}^{d-D} E_{cons}(i, n) \quad (4)$$

where α is the weight factor with value $0 \leq \alpha \leq 1$.

To determine the most suitable values for α (weight factor) and D (number of past days) that give the minimum prediction error, $N = (288, 96, 72, 48, 24)$, $0 \leq \alpha \leq 1$, $2 \leq D \leq 20$ are investigated. For a given N , the objective is to find the optimised value of α and D which yield the minimum prediction error for a given traffic volume and street light topology. The accuracy of EWMA in predicting E'_{demand} is evaluated with mean absolute error (MAE) and is given by:

$$MAE = \frac{1}{N} \sum |E'_{demand} - E_{demand}| \quad (5)$$

where E'_{demand} is the predicted energy demand and E_{demand} is the actual energy consumed by a street light while providing the optimum lighting conditions.

In order to evaluate the validity of the proposed prediction algorithm, the dynamics of a linear street light topology in a residential area have been considered. This topology

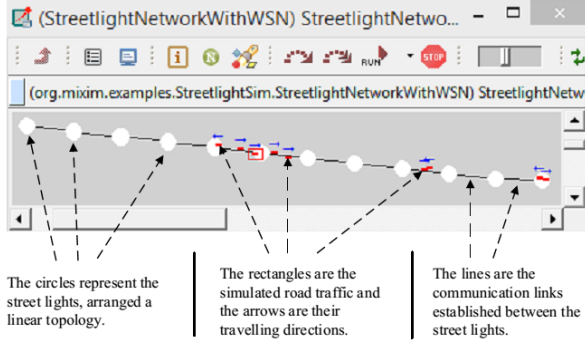

Figure 4. Graphical user interface of StreetlightSim showing the simulation with 12 street lights, in a linear topology together with simulated road traffic.

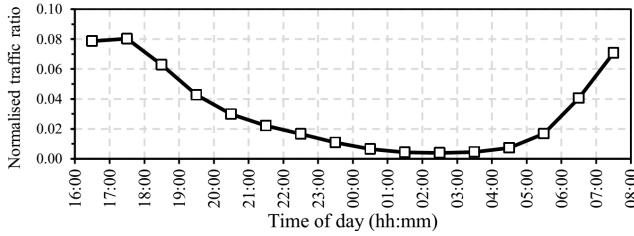

Figure 5. Traffic distribution ratio by time for the average weekday vehicular traffic (adopted from [22]).

consists of 12 street lights distributed across 360 m of road, see Figure 4. The data set is generated by StreetlightSim [21] according to the United Kingdom (UK) weekday traffic pattern (see Figure 5 [22]), with an overall traffic volume of 1347 vehicles per day. This traffic volume represents the median ‘annual average daily traffic flow’ value for residential roads in Southampton, UK [23], and was evaluated over a period of 20 days.

The results can be used to search for optimal values for N , D , and α . For example, Figure 6 shows the mean absolute error (MAE) for EWMA with $D = 3$ days and varying N and α values. As shown in the figure, EWMA gives a minimum prediction error when $\alpha = 0.8$ and $N = 288$. This means that the lighting scheme can begin its predictive behaviour after collecting 3 days of historical data. However, as the N value increases, larger α values are optimal. This implies that the term E_{cons} (i.e. the amount of energy used during the previous time step) has trivial weight to overall prediction accuracy with decreasing N values.

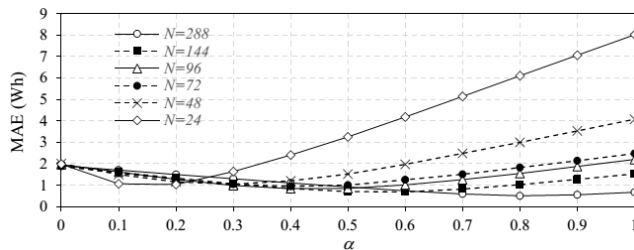

Figure 6. Prediction error of EWMA with $D = 3$ days against increasing α and N values.

Figure 7 shows MAE values of various N and D values. For each combination, the optimal (i.e. resulting in the lowest MEA) value of α was selected. While α is purely parameter that tunes that accuracy of the EWMA, N and D both have implications on the storage needed on the embedded device. Thus, the selection of D and N values should consider the target platform. Based on the results in Figure 7, $D = 3, N = 288$ (which had a corresponding optimal value of α) gives the lowest MEA while requiring comparatively minimal resources. Hence, these values are used in the simulation results presented in section 4.

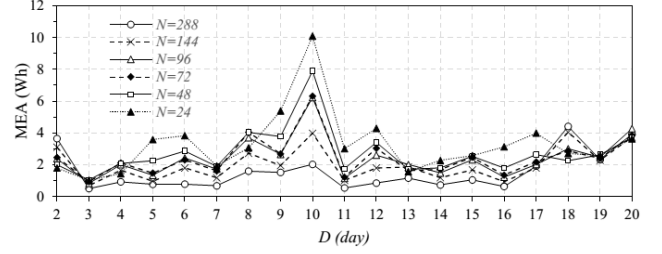

Figure 7. Optimised mean absolute error (MAE) of EWMA with various N values against increasing D values for optimal α .

3.2 Sunrise Prediction Algorithm

In the previous section, E'_{demand} is a summation of E_{cons} terms. These represent the estimated street light operating time until sunrise for a particular day. The required number of terms is determined by the predicted next sunrise time, i.e. the time at which street lighting is no longer needed.

The next sunrise time can be estimated using D days of historical data. For example, Figure 8 shows a snapshot of the estimated sunrise times t'_{rise} compared to actual sunrise times t_{rise} . The t'_{rise} times are estimated using simple moving average (SMA) of three previously stored sunrise times. For the purposes of this paper, ‘sunrise’ is considered to be the time of day when solar power readings first exceed the threshold value of 0.03 W/m^2 (approximately 7.5 lux, a typical light level where street light will turn off).

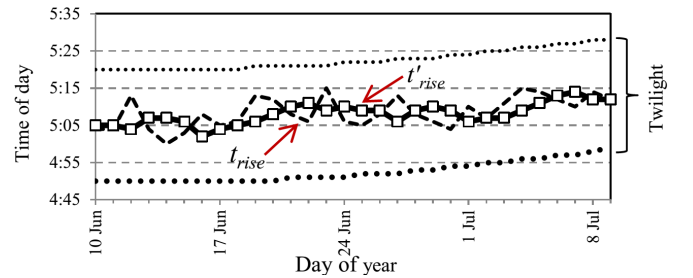

Figure 8. The predicted t'_{rise} values using SMA compared to actual t_{rise} values.

Based on the observations, SMA gives a reasonable estimation as the t'_{rise} values are within the civil twilight time zone —when street lights are expected to be switched off. Using solar data from [24], the t'_{rise} values exhibit a mean absolute error of 3.5 minutes. This error is insignificant compared to the overall duration of street lighting.

3.3 Modulation to the Optimum Lighting Conditions

When the energy stored is limited, and predicted to be insufficient to sustain the operation of the system with the brightness levels requested by TALiSMaN, TALiSMaN-Green modulates the lighting brightness. The optimum lighting conditions are modulated by the conditioning factor, the ratio of E_{stored} to E'_{demand} at timeslot n , and given by:

$$\phi'(n) = \begin{cases} \phi \frac{E_{stored}(n)}{E'_{demand}} & E_{stored}(n) < E'_{demand} \\ \phi & E_{stored}(n) \geq E'_{demand} \end{cases} \quad (6)$$

where ϕ' is modulated street light brightness and E_{stored} is the energy estimated to be stored in the energy storage device, typically the battery, at timeslot n .

4 Evaluation and Results

TALiSMaN-Green has been implemented in Streetlight-Sim [21], with the linear topology described earlier. Along with generation of traffic patterns, StreetlightSim also allows the performance of the street light network to be modelled and its overall utility to be evaluated. For ease of analysis the energy harvested, and hence the energy stored, is abstracted to a static level. These levels are 10%, 30%, 50%, 70% and 90% of the energy actually required for a period of lighting operation. As the effectiveness of the sunrise prediction algorithm has already been evaluated in section 3.2, here we assume that street lights operate from 16:00 until 08:00 the next day, which represents one of the longest street light operational hours during the winter months in the UK. During the simulations, an additional 14% of pedestrian traffic is also included. This value is based on data supplied by Southampton City Council [25].

4.1 Modulation of light brightness

Figure 9 shows the conditioning factor (E_{stored}/E'_{demand}) when TALiSMaN-Green is evaluated with various available energy levels. At the beginning of the simulations, the conditioning factor is relatively consistent, but widely fluctuates towards the end of the street light operational hours. This trend shows that EWMA is able to predict the energy demand accurately most of the time. Nevertheless, the conditioning factor begins to fluctuate widely after 06.00. One of the causes of this trend is that conditioning factor is over

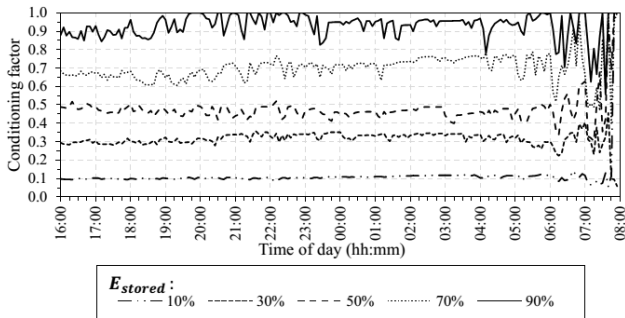

Figure 9. Simulation results showing the conditioning factor while TALiSMaN-Green is evaluated with different available energy levels.

controlled when a nearly depleted energy storage encounters a increasing traffic volume (see Figure 5).

4.2 Street light operational lifetime

Figure 10 shows the residual energy of the street lights while operating TALiSMaN-Green compared to TALiSMaN. As shown, the original TALiSMaN scheme fails well before sunrise. The advantage of TALiSMaN-Green is more significant with lower available energy, as shown in Figure 11 (b) and (c) where street lights start with only 30% and 50% of the energy they need to operate TALiSMaN for the complete night.

4.3 Street light utility

The usefulness of street lighting for different road users is measured by a street light utility model. Due to space constraints, readers are referred to [21] for details of this model.

The impact of modulating the optimum lighting conditions on the resultant street light utility are shown in Figure 11. The street light utility experienced by road users is dependent on the conditioning factor discussed in section 3.3. The aim of TALiSMaN-Green is to deliver consistent usefulness across the whole night. Based on the simulation results, while TALiSMaN provides either near-perfect or zero utility, TALiSMaN-Green achieves considerably more consistent utility throughout the duration of the night. This indicates that the EWMA delivers sufficiently accurate predictions of E'_{demand} . It is worth noting that the peak utility of TALiSMaN-Green is typically less than the peak utility delivered by TALiSMaN. On average, TALiSMaN-Green gives 31%, 50% and 91% average street light utility values for initial E_{stored} values of 30%, 50% and 90% respectively.

5 Conclusions

This paper has proposed TALiSMaN-Green, an adaptive lighting scheme for energy-harvesting street lights. It incorporates TALiSMaN, a lighting scheme that conserves energy while maintaining the usefulness of grid-connected street lights by detecting road users and dynamically setting the brightness pattern of lights in their vicinity. TALiSMaN performs relatively poor for off-grid street lights with limited energy storage, as it can allow energy reserves to become depleted before sunrise meaning that street lights will turn off completely. TALiSMaN-Green overcomes these limitations, by using a predictive algorithm which forecasts the energy demand of the street light over a complete night. Combined with knowledge of the amount of energy stored at the start of the night, and predicting sunrise times, the scheme modulates the energy demands of TALiSMaN to deliver a consistent level of usefulness to the road users, across the whole night.

The proposed scheme has been validated using StreetlightSim, through simulation of a linear street light network, with a typical pattern of traffic on a residential road. The system responds to passing motorists and pedestrians by setting nearby street lights in an appropriate pattern. Unlike TALiSMaN, the brightness pattern of street lights is modulated dependent on the energy stored and the expected activity of the light until sunrise. In a constrained environment where only 30% of the energy required to run TALiSMaN is available, the proposed scheme extends the operational time of

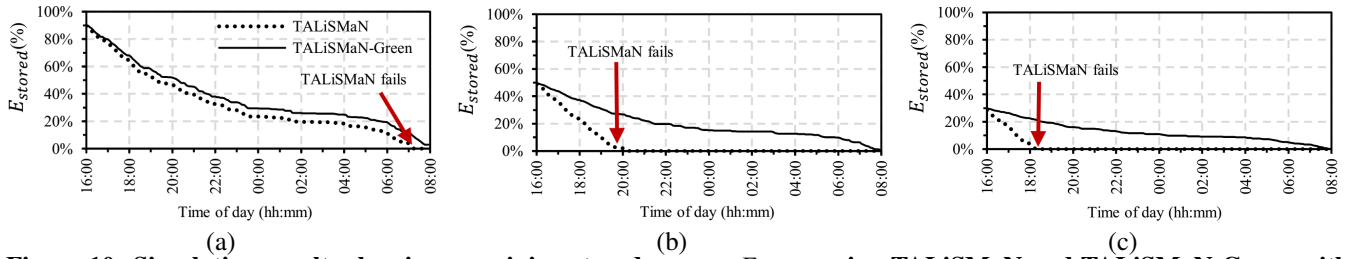

Figure 10. Simulation results showing remaining stored energy, E_{stored} , using TALiSMaN and TALiSMaN-Green with (a) 90%, (b) 50% and (c) 30% of the energy required to run TALiSMaN for a complete night.

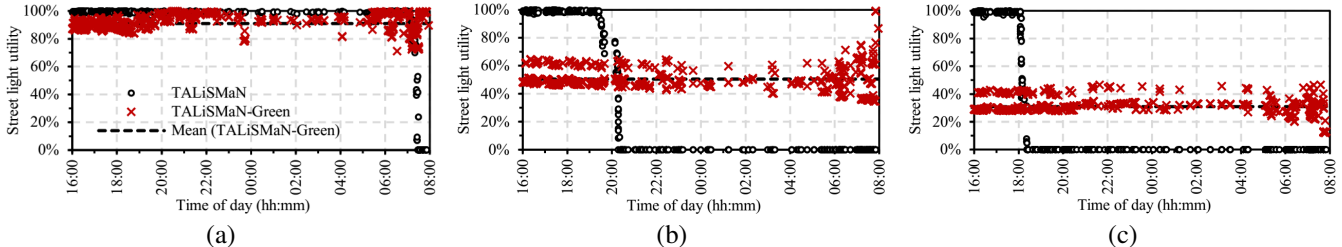

Figure 11. Simulation results showing average street light utility experienced by simulated road users using TALiSMaN and TALiSMaN-Green with (a) 90%, (b) 50% and 30% of the energy required to run TALiSMaN for a complete night.

the street light from 2 to 16 hours, and maintains the utility between 12 to 46%, with a mean value of 31% (as opposed to TALiSMaN where 60% of road users experienced zero utility). This is the first adaptive lighting scheme aimed at solar-powered street lights that sets lighting patterns based on the usefulness to road users.

6 References

- [1] P. Waide *et al.*, *Light's Labour's Lost: Policies for Energy-efficient Lighting*. France: IEA, 2006.
- [2] Northeast Group, LLC, *Global LED and Smart Street Lighting: Market Forecast (2014 - 2025)*. Washington: Northeast Group, LLC, 2014.
- [3] K. Pease, "A review of street lighting evaluations: Crime reduction effects," *Surveillance of Public Space: CCTV, Street Lighting and Crime Prevention*, vol. 10, pp. 47–76, 1999.
- [4] P. O. Wanvik, "Effects of road lighting: An analysis based on dutch accident statistics 1987–2006," *Accident Analysis & Prevention*, vol. 41, no. 1, pp. 123–128, 2009.
- [5] M. Castro *et al.*, "Smart lighting solutions for smart cities," in *Proc. 27th Int. Conf. Advanced Information Networking and Applications Workshops*, Barcelona, 2013, pp. 1374–1379.
- [6] K. Hyodhyad and P. Srikaew, "Result of road lighting energy saving project implementation through the use of public private partnership scheme," in *Proc. Int. Conf. Energy and Sustainable Development: Issues and Strategies*, Chiang Mai, 2010, pp. 1–4.
- [7] U. S. Department of Energy, "Solid-state lighting gateway demonstration results." [Online]. Available: https://www1.eere.energy.gov/buildings/ssl/gatewaydemos_results.html [Accessed: 01 Apr. 2014]
- [8] F. S. Li *et al.*, "LEDs: A promising energy-saving light source for road lighting," in *Proc. Asia-Pacific Power and Energy Engineering Conf.*, Wuhan, 2009, pp. 1–3.
- [9] Warwickshire County Council, "Part night lighting." [Online]. Available: <http://www.warwickshire.gov.uk/partnightlighting> [Accessed: 11 Nov. 2013]
- [10] C. G. Jing *et al.*, "Design of streetlight monitoring and control system based on wireless sensor networks," in *Proc. 2nd IEEE Conf. Industrial Electronics and Applications*, Harbin, 2007, pp. 57–62.
- [11] S. I. Hong *et al.*, "A development of led-it-sensor integration street-light management system on ad-hoc," in *Proc. IEEE Region 10 Conf.*, Bali, 2011, pp. 1331–1335.
- [12] M. H. Moghadam and N. Mozayani, "A street lighting control system based on holonic structures and traffic system," in *Proc. 3rd Int. Conf. Computer Research and Development*, Shanghai, 2011, pp. 92–96.
- [13] M. A. Dalla Costa *et al.*, "Autonomous street lighting system based on solar energy and leds," in *Proc. IEEE Int. Conf. Industrial Technology (ICIT)*, Vina del Mar, 2010, pp. 1143–1148.
- [14] S. Georges and F. H. Slaoui, "Case study of hybrid wind-solar power systems for street lighting," in *21st Int. Conf. Systems Engineering*, Las Vegas, NV, 2011, pp. 82–85.
- [15] R. A. Pinto *et al.*, "Street lighting system using light emitting diode (leds) supplied by the mains and by batteries," in *Proc. Int. Conf. New Concepts in Smart Cities: Fostering Public and Private Alliances*, Gijon, 2013, pp. 1–7.
- [16] J. H. Sun *et al.*, "An energy-saving control method based on multi-sensor system for solar street lamp," in *Proc. Int. Conf. Digital Manufacturing and Automation*, ChangSha, 2010, pp. 192–194.
- [17] W. Yue *et al.*, "Study of acquisition streetlights background signal by multi-sensor array," in *Proc. Int. Conf. Control Automation & Systems*, Gyeonggi-do, 2010, pp. 1000–1003.
- [18] N. Femia and W. Zamboni, "Photovoltaic-fed led lighting system with soc-based dimmable led load," in *Proc. 38th IEEE Ann. Conf. Industrial Electronics Society*, Montreal, QC, 2012, pp. 1132–1137.
- [19] S. P. Lau *et al.*, "Energy-efficient street lighting through embedded adaptive intelligence," in *Proc. Int. Conf. on Advanced Logistics and Transport*, Sousse, Tunisia, 2013, pp. 53–58.
- [20] M. I. Ali *et al.*, "Evaluation and design exploration of solar harvested-energy prediction algorithm," in *Proc. Design, Automation & Test in Europe Conf. & Exhibition*, Dresden, 2010, pp. 142–147.
- [21] S. P. Lau *et al.*, "StreetlightSim: A simulation environment to evaluate networked and adaptive street lighting," in *Proc. IEEE Asia Pacific Conf. Wireless and Mobile Technology*, Bali, Indonesia, 2014.
- [22] United Kingdom, "Traffic distribution by time of day on all roads in Great Britain," Department for Transport, UK, London, 2011.
- [23] —, "Traffic dataset: Street-level traffic figures for all regions and local authorities (Minor roads)," Department for Transport, UK, London, 2011.
- [24] NREL, "Measurement and instrumentation data center." [Online]. Available: <http://www.nrel.gov/midc/> [Accessed: 23 Jul. 2014]
- [25] European Platform on Mobility Management, "TEMS: The EPOMM Modal Split Tool." [Online]. Available: <http://www.epomm.eu/tems> [Accessed: 04 Jul. 2013]