

Evaluating the use of lithium sulphur batteries for a deep ocean pressure balanced AUV energy source

Daniel Roper* and Maaten Furlong*

* Marine Autonomous Robotic Systems Group,
National Oceanography Centre
Southampton, UK
Email: daniel.roper@noc.ac.uk

Roohollah Torabi Kachoosangi[†], Maciej Szczypiński[†]
and Ashley Cooke[†]

[†] Oxis Energy Ltd,
Culham Science Center,
Abingdon, UK
Email: info@oxisenergy.com

Abstract—Lithium sulphur batteries offer a huge potential advantage over established AUV energy sources, such as Lithium polymer or Lithium ion batteries. The high energy density and low specific gravity make them an ideal choice for pressure balanced systems which could significantly improve AUV endurance. This paper aims to evaluate the current technology readiness for deployment in the AUV industry.

I. INTRODUCTION

The use of Autonomous Underwater Vehicles (AUVs) for scientific research, commercial exploration, and military surveys has become widespread. This diverse user community is driving development towards longer mission and deeper operations while running the same high power sensor suites. These operational objectives are pushing the limits of the energy sources available to AUVs, and is driving the search for high capacity alternatives such as fuel cells and new battery chemistries.

The desire for deeper operations is also changing how batteries are packaged in an AUV. For shallower rated vehicles the battery cells and associated electronic are housed in a pressure vessels, as the pressure vessel are relatively thin and light and provides considerable buoyancy. However, as the require depths increase the weight of the vessel gets significant which restricts the amount of energy that can be carried.

An alternative approach for deeper diving AUVs is to use a compliant pressure compensated enclosure. Here the cells and associated electronics are housed in a compliant enclosure surrounded by a non-conducting medium which transmits the external pressure to the cells. Provided that the cells and electronics are pressure tolerant then there is no weight penalty for increased operating depth. This pressure tolerant approach is particularly advantageous for deeper diving submersibles as the weight of the pressure vessel becomes significant at these greater depths.

One potential candidate for a new battery chemistry which could increase the available energy for AUVs is Lithium Sulfur (Li-S). Lithium Sulfur cells offer a theoretical energy density of up to 2567 Wh/kg [2] which is significantly greater than the battery chemistries currently used e.g. Lithium Polymer (Li-Po) {600 Wh/kg} and Lithium Ion (Li-Ion) {900 Wh/kg} [1].

The current state of the art has already seen Li-S prototype cells with a specific energy density of 350 Wh/kg [2], which have a significant advantage compared with available Li-ion or Li-Po batteries which typically offer 100-200 Wh/kg depending on specific chemistry [3]. Packaged lithium sulphur cells are widely expected to achieve 400-600 Wh/kg in the near future [4], [5], [6].

Along with the higher specific energy density Li-S batteries offer a further advantage for deep AUV applications, due to the low density of the cells. This is typically 1.1 g/cm^3 , compared with 2 g/cm^3 for Li-Po cells. This lower density is beneficial as AUVs need to be close to neutrally buoyant. From this it follows any battery system (battery and associated foam) on an AUV also needs to be neutrally buoyant. The low specific gravity means that less additional buoyant materials (e.g. syntactic foam) is required per unit mass of active chemistry to achieve neutral buoyancy ($\approx 1.025 \text{ g/cm}^3$). When the mass of this saving in added buoyancy is taken into account the high gravimetric energy density is compounded, to produce a significantly higher *neutrally buoyant energy density* when compared with Li-Po cells. This combination of a high gravimetric energy density and a low specific gravity makes Li-S an ideal choice for pressure balanced AUV batteries.

However before a pressure balanced Li-S battery can be deployed onto an AUV a number of uncertainties surrounding the chemistry need to be addressed. These include: cell pressure tolerance; cell performance under a combination of high pressure and low temperature conditions; and the effect of hydrostatics pressure on cycle life and safety.

In order to evaluate the current readiness of Li-S technology for application in the AUV sector direct comparisons have been made between pouch type Ultra Light Li-S cells produced by Oxis Energy with a measured specific gravity of $\approx 1.12 \text{ g/cm}^3$ and which under test conditions achieved $\approx 250 \text{ Wh/kg}$, and Kokam SLPB526495 superior lithium polymer cells (Li-NiMgCo) chosen due to their known pressure tolerance [7]. The Li-NiMgCo cells have a specific gravity of $\approx 2 \text{ g/cm}^3$ and a measured gravimetric energy density of 182 Wh/kg at full ocean pressure (60MPa) and temperature (4°C).

The performance of both cell types has been characterized

over a range of discharge rates under full ocean depth pressures and at typical ocean bottom temperatures ($4^{\circ}C$), using the National Oceanography Center (NOC) in house pressure testing facility. Comparisons have been made of the effect of pressure on performance and cycle life of each type of cell.

A. Definitions

For the purpose of this paper the a neutrally buoyant battery system is made up of the following three elements:

- The cells
- The ancillary battery system systems (eg housings, electronics, pressure compensating fluid, etc.)
- The additional buoyant/ballast material to achieve neutral buoyancy

The combination of these three elements (not necessarily as a single unit) is said to form a neutrally buoyant energy storage system.

Definition: Neutrally buoyant energy density (V_{NB}) is the energy per unit mass of a neutrally buoyant battery system.

As the density of a neutral buoyancy battery is the same as that of seawater then the volumetric and gravimetric energy density for the system are proportional to each other. However, for comparison between batteries Wh/kg will be used in this paper when analysing the performance of different configurations.

The volume of a neutrally buoyant pressure compensated battery is dependent upon the density of the floatation used in the system. The neutrally buoyant energy density (V_{NB}) can be calculated from the nominal energy density of cells and ancillary systems ($V_{nominal}$) and the floatation density using the following equation,

$$V_{NB} = \frac{V_{nominal}}{1 + \frac{\rho_c - \rho_w}{\rho_w - \rho_f}} \quad (1)$$

Where ρ_c is the mean specific gravity of the cells and ancillary systems, and ρ_w and ρ_f are the specific gravities of the water and the required syntactic floatation respectively.

II. AUV BUOYANCY SOURCES

Buoyancy for AUVs typically comes in the form of pressure vessels, borosilicate spheres or syntactic foam. The most common source of buoyancy for deep submersible AUVs is syntactic foam which will be the focus of this section.

Syntactic foam consists of low density/hollow ceramic or glass micro or macro spheres supported in a matrix substrate [8]. The combination of high compressive strength, low permeability and positive buoyancy in sea water have made syntactic foams a popular source of buoyancy for deep submersible AUVs, as well as a valuable structural material.

There are a number of commercially available syntactic foams on the market and their densities and depth ratings are publicly available. Figure 1 shows a plot of commercially available foam products, along with a line of best fit.

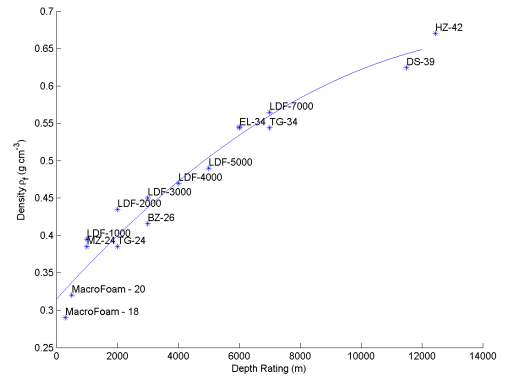

Fig. 1. Plot of density against rated depth for syntactic foam, data collated from product specifications published by Engineering Syntactic Systems Ltd, Trelleborg Ltd and Balmoral Ltd

The line of best fit from figure 1, was obtained from a quadratic fit, and can be represented by the following equation,

$$\rho_f = -0.1451e - 09D^2 + 4.524e - 05D + 0.3145 \quad (2)$$

Where ρ_f is the specific gravity of the foam in g/cm^3 and D is the maximum depth rating in m .

Another source of buoyancy for AUVs might be pressure vessels themselves, depending on their shape, cylindrical with flat end caps, cylindrical with domed end caps or spherical, it is possible to calculate the required thickness of any given material necessary to withstand a given hydrostatic pressure.

For a cylinder with flat end caps, the cylinder wall thickness can be calculated as the maximum of the thickness solution to the *David Taylor model basin* (DTMB) buckling formula and the required strength to overcome the hoop stress [9].

The DTMB buckling formula can be expressed as,

$$P = \frac{2.42E \left(\frac{t}{2a}\right)^{\frac{5}{2}}}{(1 - \mu^2)^{\frac{3}{4}} \left[\frac{L}{2a} - 0.447\sqrt{\frac{t}{2a}}\right]} \quad (3)$$

where P is the external pressure in Pa , a is the mean radius, t is the required thickness, L is the length of the tube, μ is the Poissons ratio of the material, and E is the Youngs modulus of the material. and the hoop stress thickness, can be calculated as,

$$t = \frac{aP}{(P + \sigma)} \quad (4)$$

where σ is the yield strength of the material. the end plate thickness can be calculated as,

$$t = \sqrt{\frac{3 \left(\frac{3}{\mu} + 1\right) a^2 \mu}{8\sigma}} \quad (5)$$

For a simple cylindrical pressure vessel manufactured from grade 5 titanium alloy, (mechanical properties shown in table I), with an outer diameter of $0.2m$ and a length of $0.6m$, the buoyancy available per m^3 of internal space is shown in figure 2

TABLE I
MECHANICAL PROPERTIES OF GRADE 5 TITANIUM ALLOY

E	114 GPa
μ	0.33
σ	0.91 GPa
ρ	4.42 g/cm ³

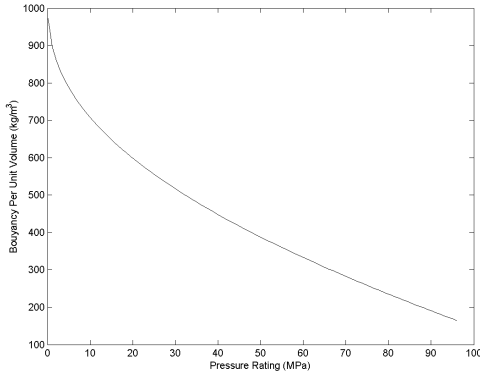

Fig. 2. Buoyancy force per unit of available internal volume for a simple cylindrical pressure housing with flat end caps, with outer diameter 0.2m, length 0.6m, manufactured from grade 5 titanium alloy, with a factor of safety of 1.2.

III. ANCILLARY REQUIREMENTS

In addition to the cells themselves the pressure compensated battery system requires

- Housing
- Battery Management System (BMS)
- Interconnection wiring
- Pressure transmission medium (typically dielectric oil)
- Volume compensator

Any battery system will require some form of mechanical housing, to contain the system and to protect the cells and other ancillary components from damage. In order to meet UN 38.3 transport regulations, there are strict requirements for the mechanical integrity of the final assembly.

All secondary lithium based batteries require some form of BMS, to regulate charging, ensure that the individual cells remain well balanced, and prevent overloading of any one cell during discharge. Battery management systems typically take the form of a printed circuit board, with both integrated circuitry and analogue components. In a fully pressure balanced system it is necessary to ensure that all components on the BMS are hydrostatic pressure tolerant. The BMS required for Li-S batteries is marginally more complex than the equivalent system required for Li-Po or Li-ion, as can be seen from figures 6 and 7 due to the complex discharge profile of Li-S batteries there is not a 1 to 1 mapping between voltage and state of charge, it is therefore necessary to include coulomb counting in the BMS to manage state of charge. This however is not expected to add significant mass to the BMS.

The pressure balancing medium, is required to ensure that the pressure is transmitted evenly throughout the system, as any pressure gradient will cause mechanical stress within the system which could damage components. As this medium is in direct contact with the cells and electronics it is necessary that it had good dielectric properties to prevent electrical short circuit.

As the system is pressurised, bulk compression of the pressure balancing medium, and system components will cause a reduction in volume, is essential that the housing remains free of voids to avoid pressure gradients, therefore some form of volume compensation, such as a piston or diaphragm arrangement is required to provide additional volume of pressure transmission medium. For some oils such as poly-dimethyl siloxane the bulk compression effect at full ocean depth (60MPa) could result in up to a 6% reduction in volume, the volume compensator, must be sized to account for this.

Ancillary requirements for a Li-S battery are almost identical to requirements for a Li-MgC based battery. A Li-S battery may however require a slightly smaller volume compensator, due to a reduction in the expected volume change with the state of charge (SOC). Whilst the volume of Li-Po cells typically varies between 2-3% due to SOC [10][11], based on an analysis of the chemistry the Li-S cells in question are expected to change in volume by $\approx 1\%$ due to SOC this has been confirmed by preliminary measurements however further quantification of this is ongoing. The implication of this is that less compensation volume is required to prevent formation of voids.

Based on NOC in house experience with previous pressure balanced lithium batteries, the required ancillary volume expected to account for $\approx 50\%$ of the volume of the final battery (not including added buoyancy). Based on NOC in house experience by using plastics for structural materials and selecting a low density pressure compensation fluid, it is thought that the mean density of ancillary material, can be kept as low as 1.2g/cm³.

IV. EFFECT OF PRESSURE ON CELLS (LI-S/LI-NiMgCo)

A. Introduction

Pouch type lithium cells, generally consist of a number of thin electrode layers, stacked flat, and inter spaced by a separator material, these layers are enclosed in a flexible aluminium pouch and immersed in an electrolyte solution.

When exposed to hydrostatic pressure, the flexible aluminium pouch transmits the pressure to the electrolyte which in turn transmits the pressure evenly throughout the cell, ensuring that no part of the cell is subjected to mechanical stress.

The expected effects of hydrostatic pressure on the cell can be summarised as bulk compression effects on electrode/separator materials and electrolyte, changes in viscosity of the electrolyte, and changes in enthalpy of both the electrolyte and electrode materials as shown in figure 3.

Bulk compression could potentially affect the layering of the electrodes affecting voltage or cycle life.

An increase in viscosity could affect the mixing within the cell, and reduce the maximum rate of discharge achievable,

A change in the enthalpy of the electrode material could increase or decrease the energy required to break the bonds between the anode materials, affecting the maximum achievable capacity.

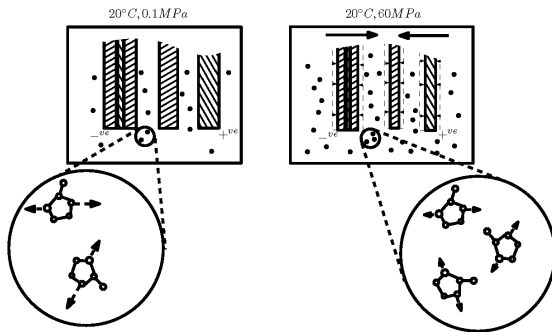

Fig. 3. Expected effects off hydrostatic pressure on lithium cells: Anode and cathode materials are subject to bulk compression, this could reduce the spacing between electrodes and hence the length of the electron path. The molar density of the electrolyte is increased, however the internal energy of the molecules is reduced, this can have the effect of increasing viscosity, reducing the speed at which reactions can take place and hence output maximum power.

B. Method

In order to test cells under pressure, a cell test housing was developed for use with the NOC in house pressure testing facility, This pressure testing facility has a temperature controlled pressure testing vessel, with a maximum pressure of $68MPa$ and temperature control from $-10^{\circ}C$ to $30^{\circ}C$. Due to safety constraints all low temperature overnight testing was restricted to $45MPa$.

The housing assembly, as shown in figure 5, was designed to house and provide connectivity for 3 cells, along with a temperature monitoring circuit. The entire assembly was oil filled, and fitted with a piston type compensator for pressure balancing.

The assembly was placed in the pressure vessel, and connected to a Maccor 4200 programmable battery testing system, which simultaneously acted as a programmable load, and provided high resolution logging of voltage and current. A schematic of the test layout can be found in figure 4.

C. Results

1) *LiMgCo*: Kokam SLPB 526495 Li-MgCo cells were tested as a control, these cells were selected as they are known to be pressure tolerant [7], and are currently used in a number of pressure balanced lithium submersible batteries.

The cells were discharged from a fully charged condition under constant current conditions of $C/5$ A, (where C is the rated capacity of the cells in *Ahrs*), over a range of pressure temperature combinations ranging from $30^{\circ}C$ and ambient pressure, to $4^{\circ}C$ at $45MPa$. Throughout all the pressure temperature combinations the cells maintained a

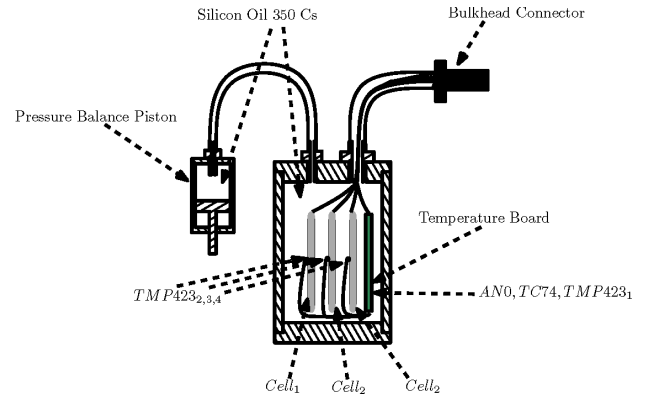

Fig. 5. Diagram of cell pressure testing apparatus, the above apparatus was inserted into the NOC in house pressure testing facility, and immerse in fluid at $4^{\circ}C$ at pressures up to $650MPa$

constant capacity of $11Whs \pm 1.5\%$. This equates to a steady $182Whrs/kg$ under deep ocean conditions.

Whilst $C/5$ is not a representative discharge rate for expected AUV operations, it was selected because it is well accepted as an industry standard.

2) *Li-S - Ultra-Light: Generation 1*: The first generation of Li-S cells tested in this study were $10.5Ah$ cell with a nominal voltage of $2V$.

These cells were tested at a number of pressure temperature combinations under constant current load conditions of $C/5$.

The resultant capacity ranged from $23.7Whrs$ at $30^{\circ}C$ and ambient pressure down to $10.7Whrs$ at $5^{\circ}C$ at $45MPa$.

Figure 6 shows discharge profiles for the Generation 1 Ultra-Light cells under various discharge conditions, it can be seen that pressure and low temperature in isolation both had an effect on the cell capacity, however when the combination of pressure and low temperature were applied simultaneously a significant non-linearity in the response occurred, resulting in over a 50% reduction in measured capacity.

The working theory was that this non-linearity, was viscosity related.

3) *Li-S - Ultra-Light: Generation 2*: Following the results from generation 1 testing, the electrolyte was modified, to 'wax point' with the intention of reducing the magnitude of viscous effects and increasing the conductivity at high pressure low temperature combinations.

For the purposes of testing, smaller $1.5Ah$ cells were produced, these cells achieved approximately $3.7Whrs$ at ambient conditions ($18 - 22^{\circ}C$) at a discharge rate of $C/5$.

These 1.5 Ah cells achieved $3.2Whrs$ at $4^{\circ}C$ and $45MPa$ under the same test conditions used with the previous iteration cells, achieving 86% of the capacity at ambient pressure and temperature. As shown in figure 7.

The test regime was modified to reflect discharge rates more typical of AUV missions. Three discharge rates were selected ($C/18$, $C/42$, $C/66$), under these conditions the cells have consistently achieved between 3.3 and $3.6Whrs$ at $4^{\circ}C$ and $45MPa$ for 5 consecutive cycles, with the variance largely

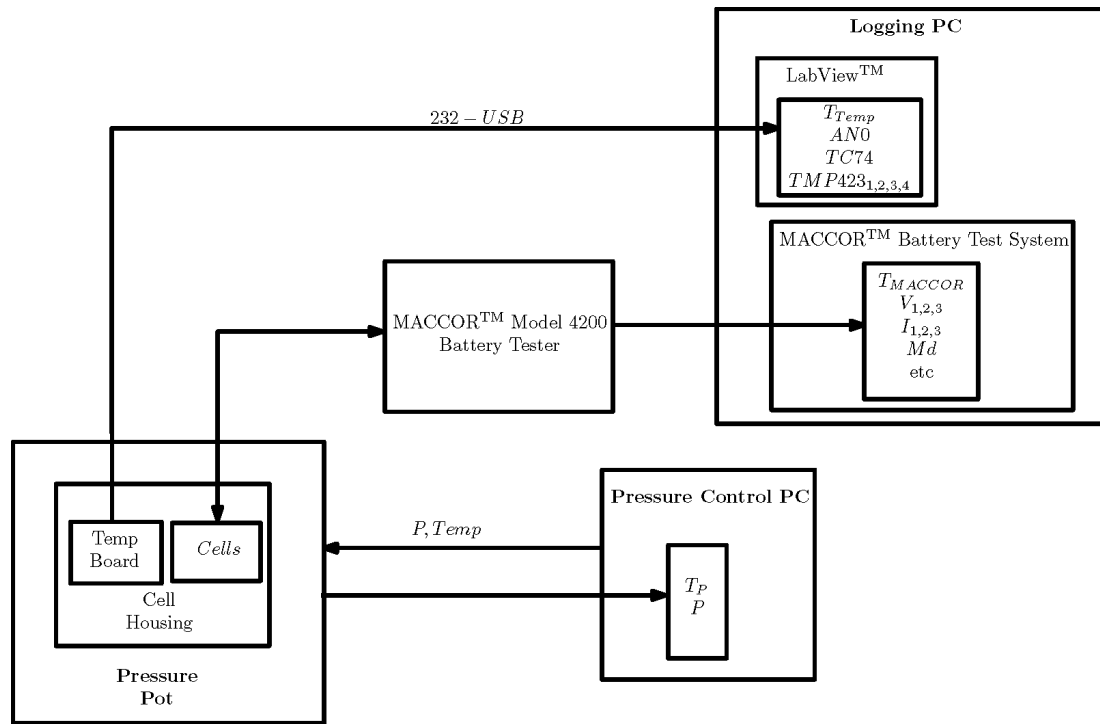

Fig. 4. Plan view of recorded and controlled variables for pressure testing cells

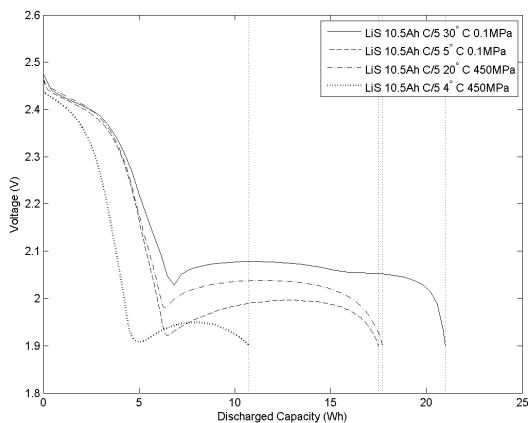

Fig. 6. Plot of pressure and temperature effect on capacity for generation 1 cells

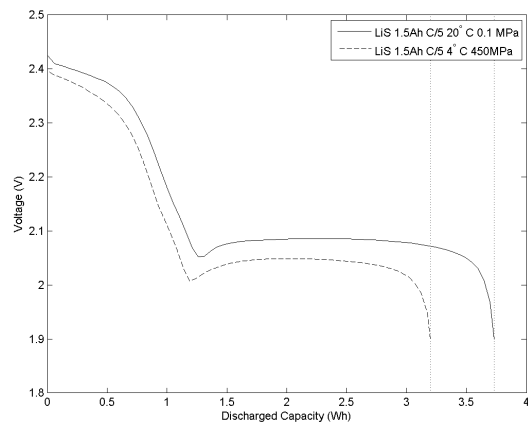

Fig. 7. Plot of pressure and temperature effect on capacity for generation 2 cells

stemming from inter cell differences rather than intra cell degradation. This equates to between 86% and 97% of nominal capacity at ocean bottom conditions, depending on mission duration.

The performance at these lower discharge rates is notably higher than at $C/5$, the cells can therefore be expected to perform at above nominal capacity during a typical AUV mission.

Long term cycle life testing of these cells is ongoing.

4) *Li-S Ultra-Light: Generation 3:* Testing is continuing on a scaled version of the generation 2 chemistry. By scaling up to 100g a 12Ah cell is achieved.

These cells have been tested at 4°C and 45MPa at $C/18$ and $C/66$ and have achieved 25.95 and 26Whrs respectively, equating to a proven gravimetric energy density of 260 Wh/kg, at ocean bottom conditions, which represents a marked improvement on currently available cells.

V. COMPARISON OF NEUTRALLY BUOYANT ENERGY DENSITY

By combining equation 1 with equation II and the measured energy density of the cell it is possible to calculate the expected neutrally buoyant energy density for a given cell technology for a neutrally buoyant pressure balanced battery system with a given depth rating. Furthermore by combining the curve from figure 2 with the measured energy density of the cells and combining with equation II, it is possible to estimate the neutrally buoyant energy density of the equivalent hard shelled pressure housed battery system.

Figure 8, show a plot of projected neutral buoyant energy densities for a variety of cell technology and design approach combinations.

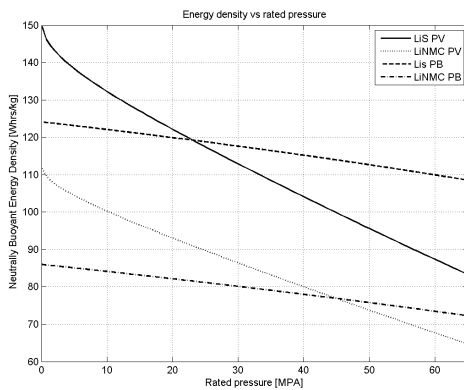

Fig. 8. Plot of the “neutrally buoyant” energy density Vs failure pressure, for Li-S and Li-NiMgCo cells in pressure vessel (PV) or pressure balanced (PB) battery design. (Assumed 10% ancillary volume at $1.5g/cm^3$ for PV system, and 50% ancillary volume at $1.5g/cm^3$ for PB system, PV is assumed to be 0.4m by 1.5m cylinder made from Grade 5 Titanium Alloy)

As can be seen from figure 8 a pressure balanced Li-S battery system offers a significant neutral buoyant energy density advantage for deep diving systems, over pressure vessel housed and pressure balanced Li-NiMgCo systems, with over 50% increase in expected neutral buoyant energy density.

Due to the low specific gravity the pressure at which a pressure balanced design becomes advantageous is lower for Li-S cells than for Li-MgCo cells. Making the design approach worthwhile for any submersibles rated for deeper than 3000m, compared with around 5000m for Li-MgCo

VI. CONCLUSION

Li-S batteries are considered to be of particular interest for deep diving applications as the relative neutrally buoyant energy density advantage over more readily available Li-Po cells is most significant for deep submersibles utilizing higher density syntactic foam.

When comparing the neutrally buoyant energy density, of Li-S cell and Li-MgC cells it can be seen that Li-S offers a potential increase up to 46% over Li-MgC

The initial poor performance of the generation 1 cells demonstrates however, that not all Li-S cells will be suitable

for a pressure balanced battery design, there are a number of Li-S chemistries nearing market readiness, it is unlikely that all of them would be able to perform under the combination of high pressure and low temperature necessary for deep sea autonomous applications.

This study suggests that there is an advantage of employing a pressure compensated design for a Li-S battery for AUVs with a rated depth greater than 3000m, a 6000m rated AUV could see up to a 30% increase in endurance by employing a pressure balanced Li-S battery system compared with pressure vessel housed Li-S battery system, and over 50% more energy density than from employing either pressure vessel housed or pressure compensated Li-MgCo battery systems.

For new developments it is likely that the limit to cycle life may be a hindrance to mass uptake of this technology, however the operational life of an AUV is likely to be significantly shorter than a terrestrial EV (total missions 200-300), therefore a cycle life of 250-500 may be sufficient to drive uptake, this is likely to be achievable in the coming future.

ACKNOWLEDGMENT

This work has been partially funded and carried out as part of an Innovate UK collaboration, between *National Oceanography Center* (NOC), *Steatite Batteries Ltd*, *Oxis Energy Ltd* and *MSubs Ltd*.

REFERENCES

- [1] M. Thackeray, C. Wolverton and E. Isaacs, *Electrical energy storage for transportation- approaching the limits of and going beyond, lithium-ion batteries* Energy and Environmental Sciences, 5, pp 7854-7863, 2012
- [2] J. Scheers, S. Fantini and P. Johansson, *A review of electrolytes for lithium-sulphur batteries*, Journal of Power Sources, 255, pp 204-218, 2014.
- [3] O. Hasvold and N. Storkersen, *Electrochemical power sources for unmanned underwater vehicles used in deep sea survey operations*, Journal of Power Sources, 96, pp 252-258, 2001.
- [4] A. Manthiram, Y. Fu and Y. Su, *Challenges and Prospects of Lithium Sulphur Batteries* Accounts of Chemical Research, 46, 5, pp 1125-1134, 2013/
- [5] C. Barchasz, F. Molton, C. Duboc, J. Lepretre, S. Patoux and F. Alloin, *Lithium/Sulfur Cell Discharge Mechanism: An Original Approach for Intermediate Species Identification*, Analytical Chemistry, 84, pp 3973-3980, 2012
- [6] V. Kolosnitsyn and E. Karaseva, *Lithium -Sulfur Batteries: Problems and Solutions 1* Russian Journal of Electrochemistry, 44, 5, pp 506-509, 2008
- [7] K. Rutherford, D. Doerffel, *Performance of lithium-polymer cells at high hydrostatic pressure*, Proc. Unmanned Untethered Submersible Technology, 1-12, 2005
- [8] N. Gupta, S. Zeltmann, V. Shunmugasamy and D. Pinisetty, *Applications of Polymer Matrix Syntactic Foams* JOM, 66, 2, pp 245-254, 2013
- [9] C. Ross, A. Spahiu, G. Brown and A. Little, *Buckling of Near-Perfect Thick-Walled Circular Cylinders Under Uniform External Hydrostatic Pressure*, Journal of Ocean Technology, 4, 2, pp 84-103, 2009
- [10] J. Lee, H. Lee and S. Ahn, *Battery dimensional changes occurring during charge/discharge cycles- thin rectangular lithium ion and polymer cells*, Journal of Power Sources, 119-121, pp 833-837, 2003.
- [11] J. Siegel, A. Stefanopoulou, P. Hagans, Y. Ding and D. Gorsich, *Expansion of Lithium Ion Pouch Cell Batteries: Observations from Neutron Imaging*, Journal of the Electrochemical Society, 160-8, pp A1031-A103, 2013.