

**National Oceanography Centre, Southampton**

**Cruise Report No. 42**

**RRS *James Cook* Cruise 35**

07-19 JUN 2009

Sidescan sonar mapping of the Whittard Canyon  
Celtic Margin

*Principal Scientist*

V A I Huvenne

2009

Contribution to the NERC Oceans2025 Programme and  
EU FP7 IP HERMIONE

National Oceanography Centre, Southampton  
University of Southampton, Waterfront Campus  
European Way  
Southampton  
Hants SO14 3ZH  
UK

Tel: +44 (0)23 8059 6575  
Email: [vaih@noc.soton.ac.uk](mailto:vaih@noc.soton.ac.uk)



## DOCUMENT DATA SHEET

|  |                                 |
|--|---------------------------------|
| <i>AUTHOR</i><br>HUVENNE, V A I et al  | <i>PUBLICATION DATE</i><br>2009 |
| <i>TITLE</i><br>RRS <i>James Cook</i> Cruise 35, 7-19 Jun 2009. Sidescan sonar mapping of the Whittard Canyon, Celtic Margin.  |                                 |
| <i>REFERENCE</i><br>Southampton, UK: National Oceanography Centre, Southampton, 35pp.<br>(National Oceanography Centre Southampton Cruise Report, No. 42)  |                                 |
| <i>ABSTRACT</i><br><p><i>James Cook</i> cruise 035 was aimed at the detailed mapping of the Whittard Canyon system along the Celtic Margin (NE Atlantic). In 12 days, &gt;700 km of track-lines were surveyed with the Towed Ocean Bottom Instrument (TOBI, carrying a 30 kHz sidescan sonar system with phase bathymetry capability, an 8 kHz chirp profiler and a magnetometer) and 6130 km<sup>2</sup> of shipborne multibeam data was acquired over the 4 main branches of the canyon. This comprehensive and highly detailed dataset will provide new insights in canyon morphology, formation, sediment transport processes and into the resulting spatial distribution of benthic habitats. In addition, the data formed an indispensable base map for the planning of ROV dives during the follow-on cruise JC036.</p> |                                 |
| <i>KEYWORDS</i><br>Celtic Margin, cruise 35 2009, HERMIONE, <i>James Cook</i> , OCEANS 2025,<br>NE Atlantic, submarine canyons, TOBI, Whittard Canyon  |                                 |
| <i>ISSUING ORGANISATION</i> National Oceanography Centre, Southampton<br>University of Southampton, Waterfront Campus<br>European Way<br>Southampton SO14 3ZH UK<br>Tel: +44(0)23 80596116Email: <a href="mailto:nol@noc.soton.ac.uk">nol@noc.soton.ac.uk</a><br><i>A pdf of this report is available for download at: <a href="http://eprints.soton.ac.uk">http://eprints.soton.ac.uk</a></i>   |                                 |



| <b><u>CONTENTS</u></b>                     | <b><u>PAGE</u></b> |
|--|--------------------|
| <b>SCIENTIFIC PERSONNEL</b>                | <b>6</b>           |
| <b>SHIPS OFFICERS AND CREW</b>             | <b>6</b>           |
| <b>ITINERARY</b>                           | <b>7</b>           |
| <b>BACKGROUND AND SCIENTIFIC RATIONALE</b> | <b>7</b>           |
| <b>OBJECTIVES</b>                          | <b>8</b>           |
| <b>NARRATIVE</b>                           | <b>8</b>           |
| <b>EQUIPMENT REPORTS</b>                   | <b>11</b>          |
| <b>RESULTS</b>                             | <b>23</b>          |
| <b>REFERENCES</b>                          | <b>24</b>          |
| <b>STATION LIST</b>                        | <b>26</b>          |
| <b>FIGURES</b>                             | <b>27</b>          |

## **SCIENTIFIC PERSONNEL**

|                 |   |
|-----------------|---|
| Huvenne, V.A.I. | National Oceanography Centre, Southampton |
| Le Bas, T.L.    | National Oceanography Centre, Southampton |
| Murton, B.J.    | National Oceanography Centre, Southampton |
| Hühnerbach, V.  | National Oceanography Centre, Southampton |
| Cassidy, M.     | National Oceanography Centre, Southampton |
| Rouse, I.       | National Oceanography Centre, Southampton |
| Webb, A.        | National Oceanography Centre, Southampton |
| White, D.       | National Oceanography Centre, Southampton |
| Rolley, L.      | National Oceanography Centre, Southampton |
| Judge, M.T.     | Petroleum Affairs Division, Dublin        |

## **SHIPS OFFICERS AND CREW**

|                 |                                  |
|-----------------|----------------------------------|
| Chamberlain, R. | Master                           |
| Gauld, P.       | Chief Officer                    |
| Mitchell, J.    | 2nd Officer                      |
| Norrish, N.     | 3rd Officer                      |
| McDonald, B.    | Chief Engineer                   |
| Elliot, J.      | 2nd Engineer                     |
| Uttley, C.      | 3rd Engineer                     |
| O'Sullivan, G.  | 3rd Engineer                     |
| Wight, I.       | Electro Technical Engineer       |
| Wythe, V.       | Deck Engineer                    |
| Stevens, A.     | Purser/Catering Officer          |
| Maclean, A.     | Chief Petty Officer - Deck       |
| Minnock, M.     | Chief Petty Officer - Scientific |
| Price, D.       | Petty Officer - Deck             |
| Moore, M.       | Seaman Grade 1                   |
| Stephens, L.    | Seaman Grade 1                   |
| Evans, L.       | Seaman Grade 1                   |
| Williams, E.    | Engine Room Petty Officer        |
| Lynch, P.       | Head Chef                        |
| Isby, W.        | Chef                             |
| Paterson, J.    | Stewardess                       |
| Conteh, B.      | Assistant Steward                |

## **ITINERARY**

Departure Vigo, Spain: 7 June 2009  
Arrival Brest, France: 19 June 2009

## **BACKGROUND AND SCIENTIFIC RATIONALE**

Submarine canyons are the main transport pathways for materials from the shelf to the deep sea. Transport processes can be catastrophic, such as dense shelf water cascading (Canals et al., 2006) or the occurrence of large turbidity currents creating scours of up to 20 m deep and 100 m across in canyon mouths (Wynn et al., 2002; Huvenne et al., 2009); or they can occur as much more gradual processes related to internal tides, that can even turn canyons into sediment traps on a medium time-scale (e.g. de Stigter et al., 2007). The catastrophic events form significant geohazards for man-made installations on the seabed, and for coastal populations (e.g. potential tsunami-generation as result of submarine landslides in canyons). In order to correctly estimate and mitigate the associated risks, a better understanding of canyon processes is necessary.

Together with the sediment, anthropogenic materials such as litter and pollutants are transported to the deep sea, while the deposition of carbon-rich fine-grained sediments may play an important role in carbon sequestration world-wide. Hence, increased understanding of canyon systems, both in terms of geological and ecological processes, is important for the development of environmental policies and sustainable, ecosystem-based deep-sea management strategies.

Years of research within large programmes such as the EU projects EUROSTRATAFORM and HERMES, led by NOCS, have provided insights in the processes and periodicity of canyon sediment transport, and its effect on canyon ecosystems. The work was mainly focussed on the Nazaré, Setúbal/Lisbon and Cascais Canyons offshore Portugal, and demonstrated the biological richness of these ecosystem hotspots (Tyler et al., 2009). However, many questions remain. Are the sediment transport processes and biological species distributions determined in the Portuguese Canyons representative for other canyon systems along the Atlantic margin? The Portuguese shelf is narrow, and although the Nazaré Canyon is not directly linked to a terrestrial river system, due to the fact that it cuts the shelf nearly all the way up to the beach, it traps most of the sediments transported along-shore. Setúbal/Lisbon and Cascais Canyon are more closely linked to the Tagus river. The nature and periodicity of sediment deposits (mainly turbidites) recovered from those canyon systems is closely linked to the climatic history of the Iberian mainland (Arzola et al., 2008). How does this knowledge translate to other canyon systems?

The study of Whittard Canyon, one of the main canyon systems along the Celtic Margin (Fig. 1) therefore is a logical extension of a long-standing research programme. The investigations started with 3 reconnaissance ROV dives during cruise JC010 in 2007 (within the HERMES project), and are now expanded under the NERC core programme OCEANS2025 and the EU FP7 IP HERMIONE. Contrary to the Portuguese Canyons, which are essentially single branch systems, Whittard Canyon is a dendritic system with 4 main branches. Those cut deeply into the Celtic Shelf, but

due to the width of that shelf, Whittard Canyon is somehow decoupled from a direct terrestrial input. Large sand dunes on the Celtic Shelf illustrate the effect of high-energy tidal currents and internal waves (Heathershaw & Codd, 1985; Zaragosi et al., 2000). Surprisingly, the morphology of certain dune fields suggests both transport into, and away from, the canyon heads (Cunningham et al., 2005).

From their work on the fan deposits exiting Whittard Canyon, Toucanne et al. (2008) and Zaragosi et al. (2000) demonstrated the relationship between palaeo-climatic conditions and the frequency and intensity of turbiditic events. During sea-level lowstands and glacial times the system was dominated by high-frequency low-density fine-grained turbidites, while during highstands the turbidites had a higher density and contained more coarse-grained material imported from the shelf. Toucanne et al. (2009) related some of the glacial deposits to the (catastrophic) activity of the 'Fleuve Manche' (English Channel) paleo river. The present-day regime of such processes, and their effects on canyon morphology, on benthic biodiversity and on species distribution within the canyon, are not yet assessed.

## **OBJECTIVES**

The overall aim of JC035 was to characterise the Whittard Canyon system in terms of morphology and substrate in order to increase the understanding of (1) sediment transport processes and their periodicity in the canyon and (2) the spatial distribution of benthic habitats. In addition, the cruise had to provide an indispensable dataset to support ROV operations during the follow-on cruise, JC036.

In particular, the objectives of JC035 were:

- to map the main branches of the Whittard Canyon system in the highest resolution possible, using shipborne multibeam and 30 kHz TOBI sidescan sonar.
- To test the G&G group's new EdgeTech dual frequency sidescan sonar system and where possible to use it to map cold-water coral occurrences in the canyon heads in high resolution

## **NARRATIVE**

*Saturday 6 June 2009 (JD 157)*

Scientific party arrives on vessel, and attends safety briefing in the afternoon. TOBI team arrives in the evening.

*Sunday 7 June 2009 (JD 158)*

Sailed at 9.00 (0700z) from Vigo with moderate weather and sea state. Life boats were tested at 9.50 (0750z), we continued the passage at 10.20am (08.20z). Installation of both the TOBI and EdgeTech sidescan sonar data recording units in the lab, further preparation of equipment on deck (cable terminations etc.). A science meeting was held at 14.00 (1200z) and a boat drill at 16.15 (1415z).



*Monday 8 June 2009 (JD 159)*

Passage was continued, initially at 11 kn, however after 14.00, the winds increased and turned gradually northerly, and speeds reduced to 9 kn. Installation of the sidescan sonar systems continued. By 22.30 (2130z), we reached Station JC035-01, where a sound velocity profile was taken. Around the same time, a major fault occurred with the SBP (high-resolution sub-bottom profiler), which appeared to be due to a blown microfuse. No spares were on board, hence the SBP was no longer available for the rest of the cruise.

*Tuesday 9 June 2009 (JD 160)*

The SVP dip was finished shortly after 01.00 (2300z), and the ship sailed on towards the start of the first TOBI survey line (westernmost branch of Whittard Canyon). We reached this position at ca. 09.00 (0700z), and TOBI was successfully deployed at a water depth of 270 m (Station JC035-02). We followed this branch downslope for the rest of the day, collecting very good EM120 bathymetry and TOBI sidescan sonar data. We also used the EM710 shallow-water multibeam in the first part of the survey, but the data quality was by far not as good as the EM120, and the system was switched off at a depth of ~600 m. In addition, we clamped a small transponder to the TOBI cable, just above the depressor weight, in an attempt to track the system with the USBL. This worked fine until we had about 2000 m cable out.

At 16.45 (1445z) we carried out an XBT cast to check the sound velocity profile (Station JC035-03)

*Wednesday 10 June 2009 (JD 161)*

Continuation of the TOBI survey, at a constant speed of 2.5 kn. All instruments behaved very well, and the weather conditions were very good. Another XBT cast was taken at 13.15 (1118z – Station JC035-04). TOBI reached the end of survey line 1 (at 48°N, the limit of the working area imposed by the French navy for the period 9-14 June 2009) at 21.45 (1945z). We started hauling in the instrument, an operation that had to be carried out with care, as the winch system is easily affected by crossing wires.

*Thursday 11 June 2009 (JD 162)*

TOBI was recovered at ca. 01.00 (2300z), and was on deck by 01.30 (2330z). We steamed to the start of TOBI survey line 2 (Station JC035-05 – eastern-most branch of the Whittard Canyon), and redeployed at 07.00 (0500z). The system was in the water by 07.45 (0545z). No USBL was used this time, as it only provided useful data for a very short stretch of the survey line. EM710 and EM120 multibeam bathymetry data were collected as well, and initially the EM710 performed better than the EM120. However, once the depth increased till over ca. 400 m, EM120 gave better results, and by the time we reached 850 m water depth, we switched of the EM710. We saw several fishing vessels in the area of deployment, and observed several fish schools on the acoustic data (profiler).

*Friday 12 June 2009 (JD 163)*

The TOBI survey line 2 was continued until ~9.30 (0730z). Unfortunately the system gyro gave up at ~ 3.00 (0100z). We hauled in the system (without spooling problems on the winch) and recovered TOBI on deck at 13.00 (1100z). Upon inspection it became clear that the housing of the gyro had flooded and that the instrument was lost.

Another transit brought us back to the shelf for the first deep-water deployment of NSRD GG's EdgeTech high-resolution sidescan sonar (Station JC035-06). The towfish was put in the water at 19.45 (1745z) and gradually cable was paid out and the ship's speed was increased to 4 kn. Good quality data was obtained at both survey frequencies of the system, but it appeared that the connection with the towfish was intermittent. Especially when paying out cable, the network connection was regularly lost for several minutes. By 22.10 (2010z) the deck unit could no longer talk to the towfish, and it was decided to bring the towfish on deck. We recovered the EdgeTech at 22.32 (2032z), and inspected the system. It was concluded that a faulty termination was most probably the cause of the the problems, and as this could not be repaired within 2 hours, we decided to head towards the start of TOBI survey line 3 and to carry out a small multibeam survey around the head of this canyon branch (using both the EM120 and EM710).

*Saturday 13 June 2009 (JD 164)*

The multibeam survey (Station JC035-07) started at 00.15 (2215z) and continued until 03.30 (0130z). TOBI was prepared next, and was deployed at 04.30 (0230z) at the start of survey line 3. We surveyed for the rest of the day, again with good quality data coming in. Two XBT casts (1500 m drops in ~2600 m water depth, Stations JC035-10 and 11) were carried out at 14.00 (1200z) and 14.17 (1217z) to check the water column structure and sound velocity. A sudden, unexpected temperature rise was observed at ca. 1200 m during the first XBT. To check if this was an instrument error or a real observation, the second XBT was carried out, which confirmed the first. Further investigation will be necessary to determine what causes this layering in the water column.

*Sunday 14 June 2009 (JD 165)*

TOBI survey line 3 was finished by 11.00 (0900z), and TOBI was hauled in, again without spooling problems on the winch. By 15.00 (1300z), the system was secured on deck, and we went on transit to the start of TOBI survey line 4. The sidescan was redeployed at 20.30 (1830z), and the next survey line was started immediately (Station JC035-12).

*Monday 15 June 2009 (JD 166)*

TOBI survey line 4 was continued successfully, through some very sinuous part of the Whittard Canyon. An XBT (T5) was taken at 9.00 (0700z), and showed a normal temperature gradient, without any abrupt changes. In the late afternoon, we continued this data collection south of 48°N, as the restrictions for work in that area, due to submarine exercises, did no longer apply.

*Tuesday 16 June 2009 (JD 167)*

Further continuation of TOBI survey line 4, now covering the levee of the lower canyon. Upon reaching the southernmost waypoint, it became clear that there were problems with the winch: slippage occurred at the level of the traction winch. As a result, the cable could only be hauled with a slow speed, initially 15 m/min, later, as less cable was out, with speeds up to 25 m/min. It was decided to continue the rest of the TOBI survey with a lower ship speed and a maximum of 7000 m of cable out, to avoid any further problems.

*Wednesday 17 June 2009 (JD 168)*

Final part of the TOBI survey. Still with a limited amount of cable out, we continued the mapping at an average speed of 2 kn, acquiring good quality data of the Whittard Channel. By 18.00 (1600z), the ship went over the final TOBI survey line 4 waypoint, and we started hauling in the vehicle by 19.30 (1730z). No further problems were encountered with the winch, and we could haul in TOBI at 40m/min. By 23.00 (2100z) TOBI was secured on deck, and we steamed to the second EdgeTech test site.

*Thursday 18 June 2009 (JD 169)*

The EdgeTech deployment site was reached just before 02.00 (0000z), and the sidescan sonar was in the water by 02.10 (0010z). The instrument was successfully brought at the right height above the bottom by paying out cable and changing ship speed between 3 and 4 knots. We surveyed the shelf edge and margin at water depths between 250 and 450m, and then continued the course downslope. Unfortunately the sidescan winch could not pay out cable quickly enough (due to a recurrent action of the break system), and gradually the sidescan height above the bottom became too high to achieve good data. At a water depth of ca. 1000 m and a sidescan sonar depth of 463m (5.40, 0340z), the connection with the system was lost again. This was the maximum amount of cable out we reached during the survey (1008m). The EdgeTech was then hauled in to a depth of ca. 210 m (ca 420 m cable out). At this point, there was no longer a problem with the communication or the network, and it was decided to turn the ship 180°, and to sail the same line in the opposite direction again to see when and if we could pick up the bottom. We received the first bottom reflections again by 7.20 (0520z), but had to break off the survey at 7.30 (0530z). By 8.00 (0600z) all the gear was secure on deck, and we could start the passage to Brest.

*Friday 19 June 2009 (JD170)*

Docked in Brest at 8.00 am (0600z).

## **EQUIPMENT REPORTS**

### **1. TOBI**

#### ***System Description***

TOBI - Towed Ocean Bottom Instrument - is the National Oceanography Centre of Southampton's deep towed vehicle, capable of operating in 6000m of water. The maximum water depth encountered during the JC035 TOBI surveys was around 4400m.

Although TOBI is primarily a sidescan sonar vehicle, a number of other instruments are fitted to make use of the stable platform TOBI provides. For this cruise the instrument complement was:

1. 30kHz sidescan sonar with swath bathymetry capability (Built by IOSDL)
2. 8kHz chirp profiler sonar (Built by IOSDL/SOC)
3. Three-axis fluxgate magnetometer. (Ultra Electronics Magnetics Division MB5L)
4. CTD (Falmouth Scientific Instruments Micro-CTD)
5. Pitch & Roll sensor (G + G Technics ag SSY0091)

6. Gyrocompass (S.G.Brown SGB 1000U)
7. Light backscattering sensor (Seapoint Turbidity Meter)

The TOBI vehicle uses a two-bodied tow system to provide a highly stable platform for the on-board sonars. The vehicle weighs 2.5 tonnes in air but is made neutrally buoyant in water by using syntactic foam blocks. A neutrally buoyant umbilical connects the vehicle to the 600kg depressor weight. This in turn is connected to the main armoured coaxial tow cable. All signals and power pass through this single conductor.

### ***TOBI Deployments***

TOBI was launched and recovered four times during the cruise, as listed below: (times are in UTC). The data were recorded on Magneto-Optical disks (Table 1)

| Deployment | Start time/ Julian day | End time/day | Comments |
|------------|------------------------|--------------|----------|
| 1          | 07:50/160              | 19:48/161    |          |
| 2          | 05:54/162              | 10:13/163    |          |
| 3          | 02:35/164              | 10:53/165    |          |
| 4          | 18:27/165              | 19:20/168    |          |

Table 1 Listing of TOBI Magneto-Optical disks

| M-O Number | File Name             | Time/ Day START        | Time/ Day STOP         | Comments / Run #                               |
|------------|-----------------------|------------------------|------------------------|--|
| 1060       | TOBI.DAT<br>TOBIa.DAT | 07:50/160<br>14:33/160 | 14:31/160<br>00:02/161 | Start run #1<br>Swapped port and stbd sidescan |
| 1061       | TOBI.DAT              | 00:02/161              | 16:11/161              |  |
| 1062       | TOBI.DAT              | 16:11/161              | 19:48/161              | End run #1                                     |
| 1063       | TOBI.DAT              | 05:54/162              | 22:03/162              | Start run #2                                   |
| 1064       | TOBI.DAT              | 22:03/162              | 10:13/163              | End run #2                                     |
| 1065       | TOBI.DAT              | 02:35/164              | 18:44/164              | Start run #3                                   |
| 1066       | TOBI.DAT              | 18:44/164              | 10:53/165              | End run #3                                     |
| 1067       | TOBI.DAT              | 18:27/165              | 10:36/166              | Start run #4                                   |
| 1068       | TOBI.DAT              | 10:36/166              | 02:45/167              |  |
| 1069       | TOBI.DAT              | 02:45/167              | 18:54/167              |  |
| 1070       | TOBI.DAT<br>TOBIa.DAT | 18:54/167<br>19:57/167 | 19:48/167<br>11:03/168 | Split files due to bad sector on disk          |
| 1071       | TOBI.DAT              | 11:03/168              | 19:20/168              | End run #4                                     |

### ***TOBI Watchkeeping***

TOBI watchkeeping was split into three, four-hour watches repeating every 12 hours. Watchkeepers kept the TOBI vehicle flying at a height of ideally 400 to 500 m above the seabed by varying wire out and/or ship speed. Ship speed was usually kept at 2.5 knts over the ground with fine adjustments carried out by using the winch. As well as flying the vehicle and monitoring the instruments watchkeepers also kept track of disk changes and course alterations.

The bathymetry charts of the work area were found to be reasonably accurate which helped immensely when flying the vehicle. Both the ship's EM120 multibeam sonar

and EA600 sonar monitors mounted in the main lab gave the watchkeepers read-outs of bathymetry and water depth.

### ***Instrument Performance***

#### *Vehicle*

The vehicle performed well throughout the survey. The trim could be a little better to give a more level attitude when in neutral flight.

#### *Profiler*

The vehicle's profiler worked well throughout the cruise enabling altitude tracking of the vehicle up to 1000m.

A Coda Octopus 360 system was used to record the profiler data in segy format. This was fed with the analogue signal from the deck unit, 4 second trigger, NMEA navigation and time data from the ship's server and a half hour time mark to trigger event annotation on the paper and screen records. The 360 was connected to a Raytheon TDU850 thermal printer to give a hard copy output.

#### *Sidescan*

Performed excellently throughout the cruise. The data was clean and free from noise artefacts. The first couple of hours of the first run had the port and starboard channels swapped. This was corrected for the remainder of the survey.

#### *Magnetometer*

The unit worked well throughout the cruise. An incorrect reading of the x value was observed in the logged data every 12 seconds, which may be explained by the asynchronous nature of the A/D converter for the unit leading to readings during a sonar transmission.

#### *Gyro*

Until half way through run 2 the unit gave very stable, reliable data. At this point the unit failed and upon recovery it was found that the pressure sphere that houses the unit had flooded. This was caused by a loose connector which had damaged an o-ring. For the remainder of the cruise the gyro was blanked off and the magnetometer used as the heading reference.

#### *CTD*

Worked well for the whole cruise once the vehicle was below 300 m. There is a connector/cable problem that is not evident on deck or at pressure but only occurs between 200 to 300 m deep.

#### *Pitch/Roll*

This unit performed admirably for the whole cruise although on deck anomalous readings were observed. This could be down to a screen being disconnected. The data looked fine.

#### *LSS*

The light scattering sensor was used throughout the cruise. Some signals were observed although from first glance it cannot be ascertained whether this was due to biology or sediment.

### *Swath bathymetry*

The swath system provided phase data for runs 3 and 4 of the survey. An amplifier fault stopped the system working for the first two runs. This was traced during the pause between runs 2 and 3 to a blown amplifier in the TVG sub system. Once replaced the system worked for the remainder of the cruise. The starboard side gave around 1.5-2 km of range. The port side was very low with at best 1 km of range over high backscatter ground.

### *Deck Unit*

The system proved very reliable in operation throughout the cruise. A voltage of 350 V was used to power the vehicle with a current of approximately 700 – 800 mA with the gyro working and 370 mA without.

### *Data Recording and Display*

Data from the TOBI vehicle is recorded onto 1.2 Gbyte magneto-optical (M-O) disks. One side of each disk gives approximately 16 hours 9 minutes of recording time. All data from the vehicle is recorded along with the ship position taken from the GPS receiver and wire out from the sheave. Data was recorded using TOBI programme LOG. A 9 minute gap occurred on disk 1070 due to a bad cluster on the disk. Other than this the recording went perfectly.

As well as recording sidescan and digital telemetry data LOG displays real-time slant range corrected sidescan and logging system data, and outputs the sidescan to a Raytheon TDU850 thermal recorder. PROFDISP displays the chirp profiler signals and outputs them to a Raytheon TDU850. DIGIO9 displays the real-time telemetry from the vehicle – magnetometer, CTD, pitch and roll, LSS – plus derived data such as sound speed, heading, depth, vertical rate and salinity.

LOG, PROFDISP and DIGIO9 are all run on separate computers, each having its own dedicated interface systems.

Data recorded on the M-O disks were copied onto CD-ROMs for archive and for importation into the on board image processing system.

The gyro in the vehicle had been removed for repair prior to this cruise. In remounting the unit the offset in the reading was changed from –10.1 degrees to +10.1 degrees. This was corrected easily in DIGIO9 – the data display programme – and was also corrected on the CD-ROMs by running programme DAYFIX - which added 20.2 degrees to the raw reading - prior to copying onto CD-ROM.

### *Summary*

The system performed well overall with some excellent sidescan imagery. The gyro flooding is a setback as this design is no longer manufactured so a replacement is not obvious.

*Ian Rouse, Dave White and Andy Webb*

TOBI technical reference: 'TOBI, a vehicle for deep ocean survey', C. Flewelling, N. Millard and I. Rouse, Electronics and Communication Engineering Journal April 1993.

e-mail: [ianr@noc.soton.ac.uk](mailto:ianr@noc.soton.ac.uk)

url: <http://www.noc.soton.ac.uk>

## **2. EdgeTech sidescan sonar**

The new sidescan sonar system trialled on this cruise was a digital EdgeTech. It consists of a dual frequency (120/410 kHz) dual pulse (chirp frequency modulated) towfish – model 4200-FS – depth-rated to approximately 1500 m (Fig. 2). The maximum range on the low frequency settings (120 kHz) is just short of 500 m, whereas the high frequency setting operates to a maximum of around 150 m. Depending on the range settings chosen, the along track resolution is 2-2.5 m (120 kHz) and 0.5-1 m (410 kHz), the across track resolution varies between 8 cm (120 kHz) and 2 cm (410 kHz) respectively. The towfish is also equipped with heading, roll and pitch sensors, as well as an altitude sensor.

The sonar transducers on the 48 kg stainless steel tow body (1.25 m long, 12 cm diameter) are rated to 6000 m, allowing them to be mounted onto a deep-water ROV or AUV. A suitable new electronics housing with deep-water depth rating however would be necessary.

The maximum cable length with which this system can be operated is 6000 m, beyond that the signal attenuation along the cable will be bigger than the signal strength itself. During this cruise a CTD cable of approximately 1500 m length was used on an electric oceanographic winch. The wire-out was recorded with a cable counter sheave. The connection between the winch and the telemetry unit in the lab was done with a 100 m Kevlar decks cable. In order to improve the wire-out versus depth ratio, a deep-dive wing was attached to the towfish (Fig. 2). For sonar positioning, a USBL acoustic tracking system (Sonardyne, Super Sub Mini-MF) was attached to the towcable.

### ***Digital interface and data logging***

The digital interface (701-DL) unit provides the link between the logging PC laptop with the EdgeTech's sonar acquisition software (Discover software) and the 4200-FS towfish. The communication between the digital interface and the laptop is made via an Ethernet LAN connection using TCP/IP protocols. The telemetry for data and towfish control is also via TCP/IP protocols over an ASDL link using the 701-DL Ethernet connection and ASDL modem. The sonar data was logged onto the laptop's harddisk, at an average rate of about 1.6 GB per hour of operation (Fig. 3).

### ***System performance and operation***

Overall, the sonar system trials were successful, although some technical problems still have to be monitored and/or overcome before the system is fully operational. In particular, there were slight problems with the newly installed winch controller. It appears that the motor brake cuts in when cable is being paid out. The effect on the sonar record is quite substantial as it produces lots of instability in the towfish (mostly

pitch motion). Lack of time to perform a complete winch test prior to shipping is the reason why the problem could not be identified before use with the EdgeTech sidescan. It will be rectified upon arrival in Southampton.

Secondly, during both deployments telemetry communication link failures occurred. It is thought that a faulty cable connection in the winch cable to towfish termination caused a communication failure about 3 hours into the first survey; from 1740 hrs to 2040 hrs on June 12th. It was decided to abandon the first trial run and recover the towfish. The repair of the faulty termination was started immediately and finished by the next morning.

The maximum wire out on this first run was 545 m, which at 4 knots speed brought the towfish to a depth of 180 m (cable versus depth ratio 3:1; at 2.5 knots speed this ratio improved to 2:1). This is a slight improvement compared to previous surveys where no deep-dive wing was used (ratio there was almost 4:1).

During the second deployment, which started at 0010 hrs and finished at 0750 hrs on June 18<sup>th</sup>, another telemetry link failure occurred just over three hours into the survey again – it is not sure if this timing is pure coincidence or not. The maximum cable deployed at the time was 1000 m; the corresponding depth of the towfish was 490 m (at 2.5 knots speed). A deeper deployment was again aborted. Although the telemetry error messages were similar to the ones on the first deployment, tests imply that the sonar termination this time was intact; hence the fault might also be occurring either in the digital interface or the laptop PC. This needs to be monitored during the coming deployments.

### ***Preliminary results***

The trial deployments were carried out over mainly flat and homogenous terrain. Apart from a few trawl marks, no interesting geological features were found during the first survey. On the second run, however, the flat seabed above the canyon head was covered by many trawl marks. The canyon head also showed indications of potential mass wasting. Downslope from the shelf, in a water depth of around 250 m, several almost circular high backscatter patches were found. Their resemblance is somewhat similar to sonar imagery of known cold-water coral mounds built by *Lophelia pertusa*, although they would need further investigation to confirm this interpretation (Fig. 4; see Freiwald et al. 2002).

*Veit Hühnerbach & watchkeepers*

## **3. Acoustic data processing**

### ***Simrad EM120 Multibeam bathymetry and backscatter***

#### ***Bathymetry***

The shipboard EM120 data was logged and saved in one hour segments (\*.all, \*.ix1 and \*.ix2 files). Processing of these data was carried out with the CARIS HIPS software version 6.1, a commercial package running under Windows XP, provided by the science party.



The setup of a CARIS HIPS project requires initial configuration of the positioning of the component parts of the multibeam system such as the transmit and receive transducer arrays, DGPS receiver, and motion sensor reference unit (MRU). These were measured on the ship to a reference point previously and thus easily entered into HIPS. The measurements were taken from the BLOM survey (June 2006, Table 2).

Table 2 Positioning of EM120 and DGPS antenna on the *James Cook* relative to the motion sensor unit (in millimetres)

|                                     | <b>X (+ve stbd)</b> | <b>Y (+ve fore)</b> | <b>Z (+ve up)</b> |
|-------------------------------------|---------------------|---------------------|-------------------|
| <b>DGPS Receiver</b>                | 509                 | -2648               | 31451             |
| <b>EM120 Receive Array</b>          | 954                 | 14092               | -6926             |
| <b>EM120 Transmit Array</b>         | 1832                | 19199               | -6944             |
| <b>Motion sensor Reference unit</b> | 0                   | 0                   | 0                 |

Positions can be verified within HIPS with a graphical diagram in 3D (Fig. 5).

The data was imported into a HIPS Project file from the raw archive format during the cruise. As the ship was generally moving slowly (2.5 kts) when towing TOBI, the quality of bathymetric data was very good. Thus automatic filtering was omitted, and only hand editing was carried out. The swath editor was used to edit the raw bathymetry values before geographic registration. The quickest and best method was found to be using the 3D editor which allows the user to view, rotate and edit the soundings (Fig. 6).

Zero tide was assumed for the survey as no tide gauge data was available and it was assumed that tidal variations would probably fall into the error margin of the bathymetry values. Several sound velocity profiles were taken during the survey. As no calibration patch test was performed the calibration results created at installation were used. These were:

Roll error =  $-0.07^\circ$

Pitch error =  $0.01^\circ$

Gyro error =  $0.01^\circ$

These are applied during geographic registration.

After geographic registration on a UTM Zone 29 (WGS84) 50-metre grid, the data were viewed in colour relief. The subset editor was used to identify the points where obvious problem bathymetry data were seen, and the points were removed.

The final mosaic can be exported to an image or to ASCII XYZ. Grids for software packages such as GMT and ERDAS Imagine version 9.3 were created. The depth values were multiplied by -1 to get proper topographic heights.

### ***Backscatter***

The processing of multibeam backscatter data is often forgotten or ignored. As a source of data that has already been collected, it provides a substantial added value, although in this case the backscatter data never reached the same resolution as the TOBI sidescan sonar records.

Initially the archive files are uncompressed and converted into their individual files using the Simrad Neptune software system “Replay”. For example a file 0208 such as:

| Date       | Time  | Size | Name                                  |
|------------|-------|------|---------------------------------------|
| 31/05/2008 | 09:05 |      |                                       |
|            |       |      | 0208_20080531_090512_RRSJamesCook.ix2 |
| 31/05/2008 | 09:05 |      |                                       |
|            |       |      | 0208_20080531_090512_RRSJamesCook.ix1 |
| 31/05/2008 | 09:05 |      |                                       |
|            |       |      | 0208_20080531_090512_RRSJamesCook.all |

converts to:

| Date       | Time  | Size    | Name                                |
|------------|-------|---------|-------------------------------------|
| 31/05/2008 | 09:05 | 491300  | 0208_20080531_090512_00_01.depth    |
| 31/05/2008 | 09:05 | 18252   | 0208_20080531_090512_00_01.ind      |
| 31/05/2008 | 09:05 | 1308    | 0208_20080531_090512_00_01.para     |
| 31/05/2008 | 09:05 | 58124   | 0208_20080531_090512_00_01.pos      |
| 31/05/2008 | 09:05 | 2732    | 0208_20080531_090512_00_01.sfsvp    |
| 31/05/2008 | 09:05 | 2241188 | 0208_20080531_090512_00_01.sidescan |
| 31/05/2008 | 09:05 | 58124   | 0208_20080531_090512_01_01.pos      |
| 31/05/2008 | 09:05 | 58124   | 0208_20080531_090512_03_01.pos      |
| 31/05/2008 | 09:05 | 17859   | 0208_20080531_090512.linestat       |
| 31/05/2008 | 09:05 | 663     | 0208_20080531_090512.plotstat       |
| 31/05/2008 | 09:50 | 60      | adm.blocks                          |
| 31/05/2008 | 09:50 | 105     | adm.data                            |
| 31/05/2008 | 09:50 | 332     | current.line                        |
| 31/05/2008 | 09:50 | 222984  | line.sensors                        |
| 31/05/2008 | 09:50 | 4       | projection.data                     |
| 31/05/2008 | 09:50 | 67400   | survey.lines                        |
| 31/05/2008 | 09:50 | 16640   | TestLane.errTele                    |
| 31/05/2008 | 09:50 | 191     | uncertainty.param                   |

The latter 8 files are updated by subsequent conversions but are required for processing. All these processed (“proc”) files were transferred to the PRISM Software system (Version 4.0; LeBas, 2005). The formats of the “proc” files are described in the EMx\_IO library. Simrad has kindly lent the Linux version of the library files and thus the data could be decoded and raw data transferred to NetCDF format, similar to sidescan imagery. The processing proceeded in a similar way to the TOBI imagery (see below).

The PRISM configuration file for EM120 backscatter data that was used:

```
mrgnav -i %1 -o %0_1 -n navfile.nav -l 0,0
filter -i %1 -o %0 -b 1,21 -z -v 130,255
filter -i %1 -o %0 -b 1,301 -h -v 130,255
filter -i %2 -o %0 -b 31,301 -L -v 130,255
wtcombo -i %2 , %1 -o %0 -c 1,1 -a -128
```

```

restorehdr -i %1 -h %5
resol -i %2 -o %0 -r res
shade -I %1 -o %0 -n 128 -t 1,254

```

To explain this in sonar terms (in order):

- Add the ships DGPS navigation to the imagery
- Low pass filter of the imagery taking a kernel of 1 by 21 pixels and filling zero pixels with an average value. Valid pixels have values between 130 and 255.
- High pass filter of the imagery taking a kernel of 1 by 301 pixels and filling zero pixels with an average value. Valid pixels have values between 130 and 255. The results are biased by adding 128
- Low pass filter of the imagery taking a kernel of 31 by 301 pixels and filling all valid pixels with the average value. Valid pixels have values between 130 and 255.
- Weighted combination of the high and low pass filters by addition of pixels and subtraction of 128.  
i.e.  $X_{new} = 1 * (\text{Average}_{\text{large area}}) + 1 * (X_{old} - \text{Average}_{\text{line}} + 128) - 128$
- Restore the header information to the weighted combination file, as the filter process removes the sidescan information embedded in the NetCDF file
- Reduce the resolution of the imagery to the required value
- Across-track equalisation of illumination on an equal range basis. This assumes that the backscatter from a particular range should average a given amount for each piece of data. The near-range pixels and far-range pixels are generally darker than mid-range pixels. This is due to the transducer's beam pattern and differences in seafloor backscatter response in terms of angle of incidence. The approach to this is to amplify the near and far-range pixels by about 1.5 and reduce the mid-range pixels by 0.8. These values are calculated from the individual segment being processed. Values are normalised to a pixel value of 128.

The area was sufficiently large for the area to be covered by four maps (Table 3; Fig. 7). Unlike bathymetry data, the imagery cannot be averaged and thus mosaics must have ensonification coherence (i.e. keeping the individual pieces of mosaic as big as possible). Thus 4 mosaics were created . These are summarised in Table 3 and Fig. 7. Processing was carried out with a grid resolution of 20m

Table 3 Boundary coordinates of EM120 backscatter map tiles

| Map No. | Min Long (W) | Max Long (W) | Min Lat (N) | Max Lat (N) |
|---------|--------------|--------------|-------------|-------------|
| 1       | -11.0813     | -9.8927      | 47.7734     | 48.4580     |
| 2       | -11.2690     | -10.5704     | 48.4580     | 49.1288     |
| 3       | -10.5704     | -9.8823      | 48.4580     | 48.9836     |
| 4       | -10.4064     | -9.9032      | 47.1789     | 47.7734     |

### ***TOBI Sidescan sonar imagery***

PRISM (Processing of Remotely-sensed Imagery for Seafloor Mapping) is a sonar software system that consists of several programs and processing scripts. The bulk of

the programs were written at the National Oceanography Centre Southampton (formerly Southampton Oceanography Centre).

The PRISM system constitutive programs are written mainly in C, and function under a variety of UNIX environments (e.g. SOLARIS & LINUX). NetCDF (Network Common Data Format) defines the basic imagery format. NetCDF is a self-describing network-transparent data format for data access provided by Unidata Program Centre. Unidata is a United States national program sponsored by the NSF, which is available to all academic communities at no cost. GMT and the MB system along with PRISM use the NetCDF format for input/output, which provides an additional degree of platform-independence. The University Corporation for Atmospheric Research holds copyright and all copyright notices are available with the PRISM source files.

The raw data were imported from CD-ROM into PRISM NetCDF. Initially the data were subsampled and averaged by 8 across-track, making pixel size 8ms or 6m. As survey speed was set to 2.5 knots (about 1.25 m/s), and mindful of TOBI's pulse repetition period of 4 seconds, the ping spacing is 5m along track. However as speeds reduced in practice during the survey to about 2 knots, it was decided to process the data at 3m resolution (subsample across track by a factor of 4). Interpolation of pixels along track at 3m resolution is required but is minimal. Le Bas and Huvenne (2007) show that maximum across-track resolution of TOBI is achieved by a subsample factor of 3 equating to 2.25m resolution but requires an unpractical survey speed of 1.1 knots to prevent interpolation of pixels along-track.

Once the imagery is converted into NetCDF format for PRISM, the header information can be checked. This information contains date, time, altitude of vehicle over the seafloor, gyro heading, roll, pitch, pressure, cable length and ship position. Values for pressure were interpolated between known points of acceptable data. Data gaps were typically only a couple of minutes long (about 30 pings). No discernable artefacts were visible in the imagery for these gaps. As the Gyro flooded part way through the survey, heading values from this sensor were ignored.

The configuration file used for the TOBI at 3m resolution was:

```
suppress_tobi -i %1 -o %0 -s 9 # 9 needed for 3m resolution
increment -i %1 -o %0
tobtvg -i %1 -o %0 -p
mrgnav_inertia -i %1 -o %0 -u 172 -n navfile.veh_nav
tobtvg -i %1 -o %0 -h -l 50 # use track heading
edge16 -i %1 -o %0 -m
pssinv -i %1 , ../bathy/allarea2merc.cdf -t -r res -o %0 -m
../bathy/map62.dat -- +proj=merc +ellps=WGS84 +lat_ts=0.0
median3 -i %1 -o %0
restorehdr_tobi -i %1 -h %3
batslr -i %4 , %2 -o %0 -r res -p -a
drpout -i %1 -o %0 -u -f -p -k 401
drpout -i %1 -o %0 -u -f -p -k 101
shade_tobi -i %1 -o %0 -t1,4095 -n 1000
```

To explain this in sonar terms (in order):

- Removal of any surface reflection (i.e. from Vehicle to the sea surface and back) – generally only a problem in shallower water depths, where a bright stripe or line is seen semi-parallel to the ship's track. Removal is only done

when the imagery is unambiguous, whether the line is true artefact and not actual seafloor feature. The result can sometimes be seen on the final imagery as a faint dark line.

- DC shift of the imagery pixels by a small amount so that shadows are not depicted with zero pixel value but as a very small return. This is because the GIS which will finally display the imagery assumes that zero pixels are of no data and therefore will be shown as transparent.
- The altitude data was quite spiky and thus was smoothed slightly
- Merging of ship navigation and cable data with the imagery and calculation of the TOBI position using an inertial navigation algorithm. The 'navfile.veh\_nav' file contains ship position and cable values and an umbilical length of 120 metre is assumed plus 52 metres from DGPS receiver to the stern. Various assumptions are applied: the cable is assumed to be straight, the cable value is assumed to be correct, zero cable is set when the depressor enters the water, and the umbilical length includes the distance between the GPS receiver and the point where the cable enters the water.
- A 10 ping smoothing filter is applied to the track heading values. The heading values are used in the geographic registration process to angle each ping relative to the TOBI position. Using the track heading, does not take account of any crabbing of the vehicle.
- Median filter to remove any high or bright speckle noise. A threshold is defined for the maximum deviation for adjoining pixels over a small area above which the pixel is replaced by a median value.
- Creation of a bathymetry datafile which corresponds to the coverage of the TOBI imagery (ping by ping). A Mercator map of the area must be available with the appropriate geographic limits. Mercator map created at 50 m resolution from the EM120 bathymetry data collected concurrently on the cruise was used.
- Median filter of the bathymetry data to remove any spikes that might be present in the original bathymetry data, kernel size 3 by 3 pixels.
- Reattach the header information to the bathymetry datafile
- True slant-range correction is calculated using the above corresponding bathymetry datafile and the TOBI imagery and the TOBI imagery is geometrically corrected. Each pixel is 4 ms and equates to 3 metre resolution, any pixel gaps on the output file are filled by pixel replication.
- Dropout removal for large imagery dropouts. When the vehicle yaws excessively it is possible for the transmit and receive phase of each ping to be angled apart. If this exceeds the beam sensitivity value ( $0.8^\circ$ ) little or no signal is received, creating a dark line on the imagery. The program detects the dropout lines and interpolates new pixel values. If more than 7 dropouts are present concurrently (28 seconds) no interpolation is done.
- More dropout removal but for smaller, partial line dropouts. If more than 7 partial dropouts are present concurrently (28 seconds) no interpolation is done.
- Across-track equalisation of illumination on an equal range basis. This assumes that the backscatter from a particular range should average a given amount for each piece of data. The near-range pixels and far-range pixels are generally darker than mid-range pixels. This is due to the transducer's beam pattern and differences in seafloor backscatter response in terms of angle of incidence. The approach to this is to amplify the near and far-range pixels by

about 1.5 and reduce the mid-range pixels by 0.8. These values are calculated from the individual segment being processed. Values are normalised to a pixel value of 1000.

As the area was relatively large and the resolution high the survey was divided into 15 maps (Table 4; Fig. 8). Each map has about 10000 by 7500 pixels and data is 16 bit, thus filesizes are about 150Mb. Mercator projection was chosen with a standard latitude of 48° N and datum WGS84.

Table 4 Boundary coordinates of TOBI sidescan sonar map tiles

| Map | Min Long | Max Long | Min Lat | Max Lat |
|-----|----------|----------|---------|---------|
| 1   | -10.4631 | -10.0641 | 47.8032 | 48.0747 |
| 2   | -10.9251 | -10.4841 | 48.0887 | 48.3463 |
| 3   | -10.4841 | -10.0431 | 48.0747 | 48.3463 |
| 4   | -11.2611 | -10.9251 | 48.3463 | 48.6178 |
| 5   | -10.9251 | -10.6416 | 48.3463 | 48.6178 |
| 6   | -10.2006 | -9.8646  | 48.3463 | 48.6178 |
| 7   | -11.2716 | -11.0826 | 48.6178 | 48.8894 |
| 8   | -10.7886 | -10.4631 | 48.6178 | 48.8894 |
| 9   | -10.1796 | -9.9171  | 48.6178 | 48.8894 |
| 10  | -11.2716 | -11.0931 | 48.8894 | 49.1400 |
| 11  | -10.5996 | -10.4946 | 48.8894 | 48.9868 |
| 12  | -10.3965 | -9.9152  | 47.1809 | 47.5117 |
| 13  | -10.3965 | -10.0641 | 47.5117 | 47.8032 |
| 14  | -10.5996 | -10.3600 | 48.3463 | 48.6178 |
| 15  | -10.4631 | -10.1796 | 48.6178 | 48.8894 |

The user has to decide where to trim overlapping imagery. Some features may be better insonified on one segment than the other (e.g. shadows) and thus can be cut around. The layers are then overlaid and a single mosaic image created. The stencilling and overlaying of layers was done the commercial software package ERDAS Imagine (version 9.3). This package has been customised to include PRISM functionality and formats. ERDAS Imagine is a powerful image processing and GIS software package and allows much image manipulation and map production. Reprojection to other coordinate systems is possible, as well as exports to other formats such as GeoTiff or ASCII xyz. The main .img format is also compatible with the Arc/Info GIS.

#### ***Navigation and winch data***

Ship time, position and cable length was obtained from the James Cook's EM120 multibeam bathymetry system data. The processing system (PRISM) for TOBI image processing and multibeam backscatter data requires navigational files to be in specific fixed format and thus a format conversion program was written.

The winch used for towing TOBI gave data via the CLAM database system and was requested from the shipboard systems periodically. The program called "wireout" then estimates the position of a towed body (TOBI) behind the ship. This assumes a given drag and viscosity of cable plus sidescan and assumes a depth value (related to the

cable length) and gives an initial estimate of the TOBI position. Final positions of TOBI are calculated within PRISM.

*Tim Le Bas*

## **RESULTS**

Overall JC035 was a great success. Without weather downtime, and with only very limited equipment-related time-loss, we covered >700 km of survey track with TOBI, and mapped 6130 km<sup>2</sup> of bathymetry with the EM120 (Figs. 9 & 10). The dataset covers the 4 main branches of the Whittard Canyon, and provides a unique basis for the study of canyon morphology and deep-sea habitats. Each of the branches has its own morphological characteristics, suggesting different formation mechanisms and contemporary sediment transport processes:

- the eastern-most branch is mainly characterised by scarps and steep walls, especially in the shallower reaches (<2000 m). At greater depths (~2500 m), an intricate pattern of small side-valleys and sharp ridges can be observed. Below 3000 m, the canyon branch becomes wider and more U-shaped, with the formation of a meandering secondary thalweg channel in the canyon floor.
- The second branch from the east has a very different appearance in the shallowest reaches: at ~ 600 m depth, the walls are covered by gullies, with a morphology reminiscent of river catchment areas. Towards the deeper waters, similar ridge/valley patterns occur as in the eastern-most branch.
- The third branch of the Whittard Canyon is mainly characterised by scarps and terraces, and by a complicated morphology. It appears as if an existing, westward directed channel was cut by the present more south-southeast-ward directed branch.
- The western-most branch appears to have less features than the other branches, although some gullies can be found in the shallowest reaches and a small area of sharp ridges/valleys is present at medium depths. Overall, this branch has a very long and straight U-shaped stretch, with a relatively flat bed and a secondary thalweg channel.
- Finally, the lower stretch of the Whittard Canyon (Whittard Channel), directed south-wards from the point where the eastern and western branches join, is a broad valley with a gradually disappearing secondary channel. It is an energetic environment, as indicated by the large number of scouring grooves and depressions, and the high backscatter signal of the TOBI data.

Those different observations strongly influenced the choice of ROV dive sites during the follow-on cruise JC036.

In addition to the main part of work, the EdgeTech tests indicated that the sidescan sonar can provide high-quality imagery, although the connection to the deck unit and the winch manipulation have to be revised. The data showed trawling activity and the potential presence of benthic communities on the shelf break around the canyon heads.

## REFERENCES

- Arzola, R.G., Wynn, R.B., Lastras, G., Masson, D.G., Weaver, P.P.E., 2008. Sedimentary features and processes in the Nazaré and Setúbal submarine canyons, west Iberian margin. *Marine Geology* 250, 64-88. doi:10.1016/j.margeo.2007.12.006
- Canals, M., Puig, P., Durrieu de Madron, X., Heussner, S., Palanques, A., Fabres, J., 2006. Flushing submarine canyons. *Nature* 444, 354-357. doi:10.1038/nature05271
- Cunningham, M.J., Hodgson, S., Masson, D.G., Parson, L.M., 2005. An evaluation of along- and down-slope sediment transport processes between Goban Spur and Brenot Spur on the Celtic Margin of the Bay of Biscay. *Sedimentary Geology* 179 (1-2), 99-116. 10.1016/j.sedego.2005.04.014
- de Stigter, H.C., Boer, W., de Jesus Mendes, P.A., César Jesus, C., Thomsen, L., van den Bergh, G.D., van Weering, T.C.E., 2007. Recent sediment transport and deposition in the Nazaré Canyon, Portuguese continental margin. *Marine Geology* 246, 144-164. doi:10.1016/j.margeo.2007.04.011
- Freiwald, A., Hühnerbach, V., Lindberg, B., Wilson, J.B., Campbell, J., 2002. The Sula reef complex, Norwegian shelf. *Facies* 47, 179-200.
- Heathershaw, A.D., Codd, J.M., 1985. Sandwaves, internal waves and sediment mobility at the shelf-edge in the Celtic Sea. *Oceanologica Acta* 8 (4), 391-402.
- Huvenne, V.A.I., McPhail, S.D., Wynn, R.B., Furlong, M., Stevenson, P., 2009. Mapping giant scours in the deep ocean. *EOS* 90 (32), 274-275.
- Le Bas, T.P., 2005. PRISM - Processing of Remotely-sensed Imagery for Seafloor Mapping - Version 4.0. National Oceanography Centre, Southampton, Southampton, p. 192.
- Le Bas, T.P., Huvenne, V.A.I., 2009. Acquisition and processing of backscatter data for habitat mapping - Comparison of multibeam and sidescan systems. *Applied Acoustics* 70 (10), 1248-1257. 10.1016/j.apacoust.2008.07.010
- Toucanne, S., Zaragosi, S., Bourillet, J.-F., Naughton, F., Cremer, M., Eynaud, F., Dennielou, B., 2008. Activity of the turbidite levees of the Celtic-Armorican margin (Bay of Biscay) during the last 30,000 years: imprints of the last European deglaciation and Heinrich events. *Marine Geology* 247, 84-103. doi:10.1016/j.margeo.2007.08.006
- Toucanne, S., Zaragosi, S., Bourillet, J.F., Cremer, M., Eynaud, F., Van Vliet-Lanoe, B., Penaud, A., Fontanier, C., Turon, J.L., Cortijo, E., Gibbard, P.L., 2009. Timing of massive 'Fleuve Manche' discharges over the last 350 kyr: insights into the European ice-sheet oscillations and the European drainage network from MIS 10 to 2. *Quaternary Science Reviews* 28 (13-14), 1238-1256. 10.1016/j.quascirev.2009.01.006
- Tyler, P., Amaro, T., Arzola, R., Cunha, M.R., de Stigter, H., Gooday, A.J., Huvenne, V., Ingels, J., Kiriakoulakis, K., Lastras, G., Masson, D., Oliveira, A., Pattenden, A., Vanreusel, A., van Weering, T., Vitorino, J., Witte, U., Wolff, G., 2009. Europe's Grand Canyon: Nazare submarine canyon. *Oceanography* 22 (1), 48-57.
- Wynn, R.B., Kenyon, N.H., Masson, D.G., Stow, D.A.V., Weaver, P.P.E., 2002. Characterization and recognition of deep-water channel-lobe transition zones. *AAPG Bulletin* 86 (8), 1441-1462.



Zaragosi, S., Auffret, G.A., Faugères, J.C., Garlan, T., Pujol, C., Cortijo, E., 2000. Physiography and recent sediment distribution of the Celtic Deep-Sea Fan, Bay of Biscay. *Marine Geology* 169, 207-237.

## STATION LIST

| Station  | Equipment | Date Start | Time Start | Lat. Start   | Long Start   | Depth Start | Date End | Time End | Lat. End     | Long. End    | Depth End |
|----------|-----------|------------|------------|--------------|--------------|-------------|----------|----------|--------------|--------------|-----------|
| JC035-01 | SVP       | 08.06.09   | 22:04      | 48°00.0000'N | 10°17.0000'W | 3904        |          |          |              |              |           |
| JC035-02 | TOBI      | 09.06.09   | 07:52      | 49°05.3910'N | 11°12.4780'W | 264         | 10.06.09 | 23:32    | 47°55.0700'N | 10°00.4100'W | 3154      |
| JC035-03 | XBT       | 09.06.09   | 14:45      | 48°50.1950'N | 11°09.1024'W | 1699        |          |          |              |              |           |
| JC035-04 | XBT       | 10.06.09   | 11:30      | 48°09.5286'N | 10°33.4444'W | 3629        |          |          |              |              |           |
| JC035-05 | TOBI      | 11.06.09   | 05:56      | 48°51.5552'N | 10°07.9439'W | 157         | 12.06.09 | 11:00    | 47°48.0100'N | 10°17.7620'W | 3893      |
| JC035-06 | XBT       | 11.06.09   | 10:30      | 48°41.1460'N | 10°03.9470'W | 1155        |          |          |              |              |           |
| JC035-07 | EdgeTech  | 12.06.09   | 17:45      | 48°54.1364'N | 10°17.3849'W | 163         | 12.06.09 | 20:32    | 48°48.5211'N | 10°26.4128'W | 209       |
| JC035-08 | MBES      | 12.06.09   | 23:45      | 48°55.7356'N | 10°32.7145'W | 186         | 13.06.09 | 01:30    | 48°56.2167'N | 10°31.1841'W | 170       |
| JC035-09 | TOBI      | 13.06.09   | 02:36      | 48°57.0052'N | 10°32.9488'W | 155         | 14.06.09 | 12:30    | 47°55.0202'N | 10°09.2810'W | 4012      |
| JC035-10 | XBT       | 13.06.09   | 12:00      | 48°37.9800'N | 10°41.7459'W | 2580        |          |          |              |              |           |
| JC035-11 | XBT       | 13.06.09   | 12:19      | 48°37.1707'N | 10°42.0507'W | 2603        |          |          |              |              |           |
| JC035-12 | TOBI      | 14.06.09   | 18:11      | 48°50.2631'N | 10°14.7320'W | 142         | 17.06.09 | 20:48    | 48°10.6341'N | 10°14.0888'W | 3669      |
| JC035-13 | XBT       | 15.06.09   | 07:00      | 48°26.6954'N | 10°24.8657'W | 2913        |          |          |              |              |           |
| JC035-14 | EdgeTech  | 18.06.09   | 00:10      | 48°35.9200'N | 9°46.9140'W  | 253         | 18.06.09 | 05:50    | 48°27.2620'N | 9°51.6620'W  | 498       |

## FIGURES

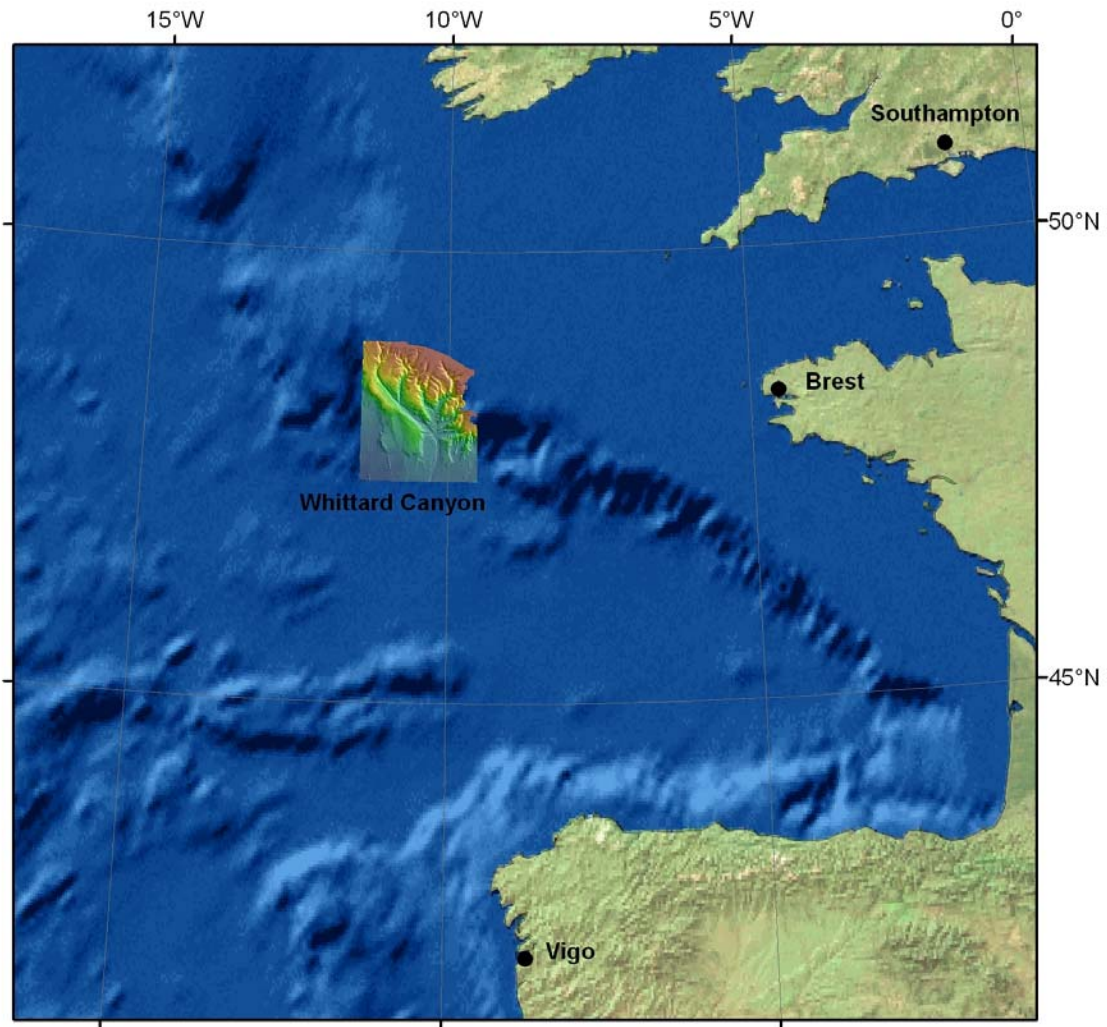

Fig. 1 Location map of the study area in relation to the ports of departure and arrival. Whittard Canyon bathymetry kindly provided by the Geological Survey of Ireland (GSI, Dublin)

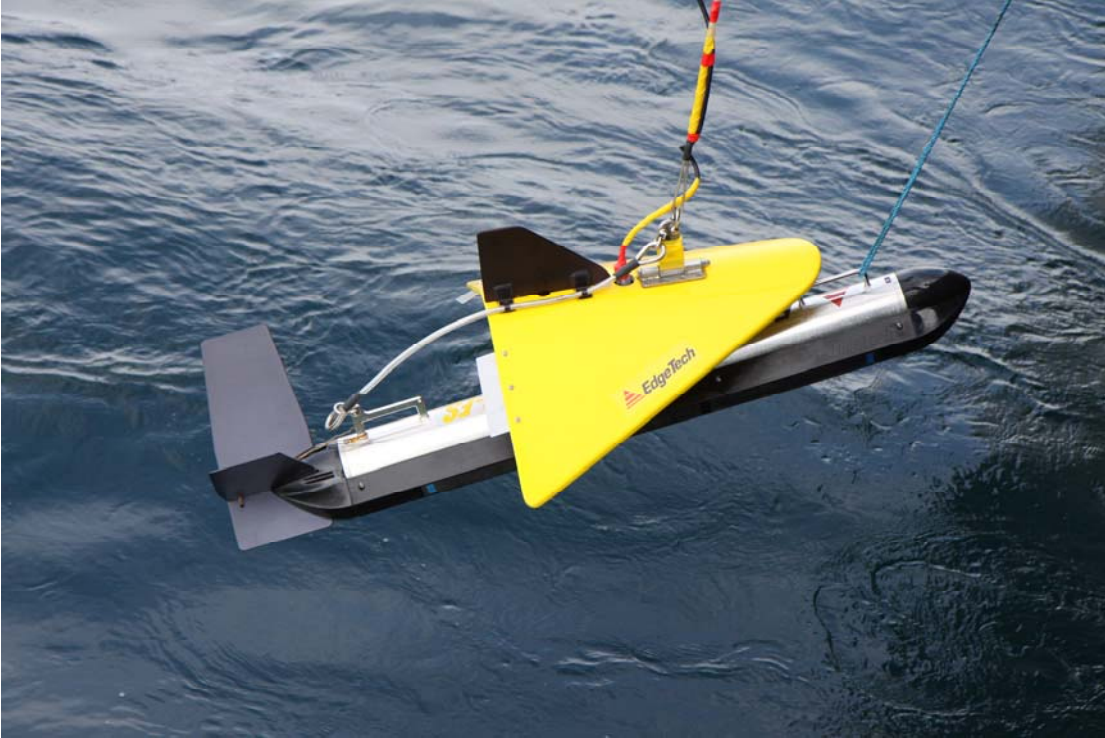

Fig. 2 EdgeTech dual frequency sidescan (4200-FS) with deep-dive wing

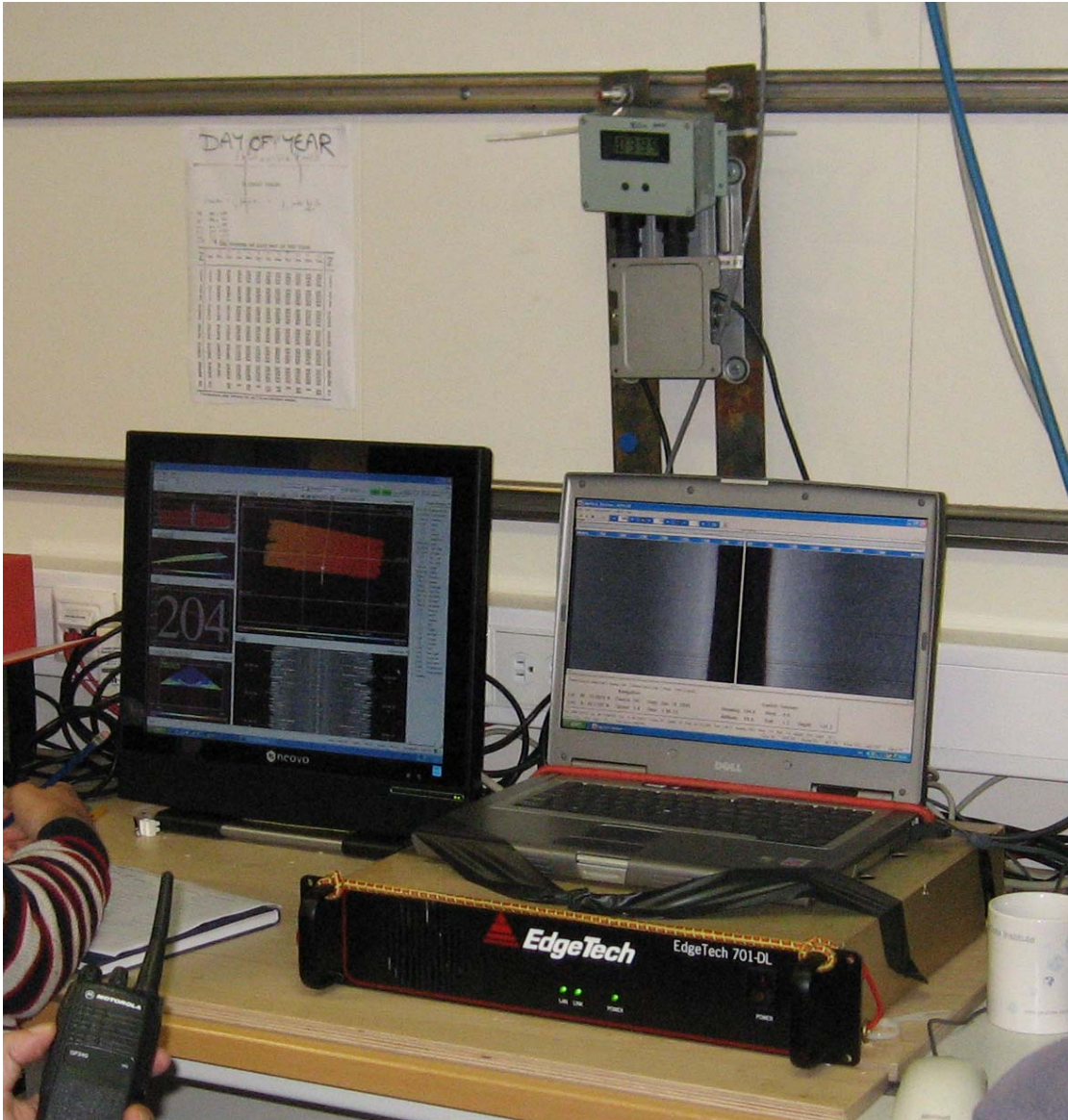

Fig. 3 EdgeTech deck unit set-up

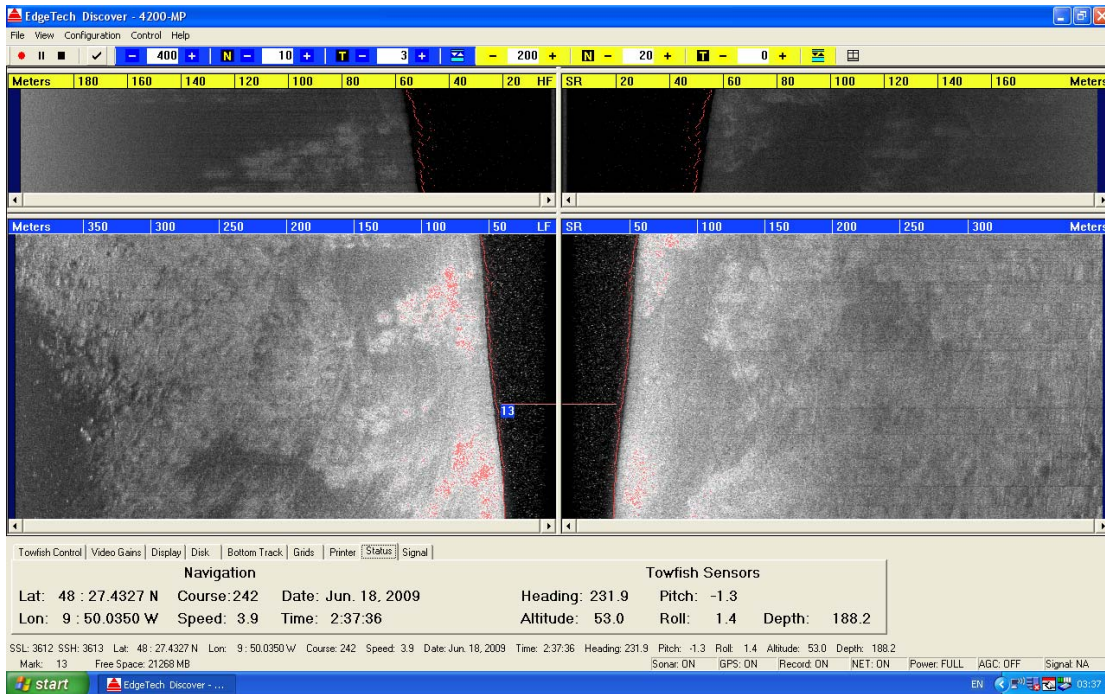

Fig. 4 Screenshot of 120 kHz EdgeTech sidescan sonar data indicating potential cold-water coral occurrences on the margins of Whittard Canyon.

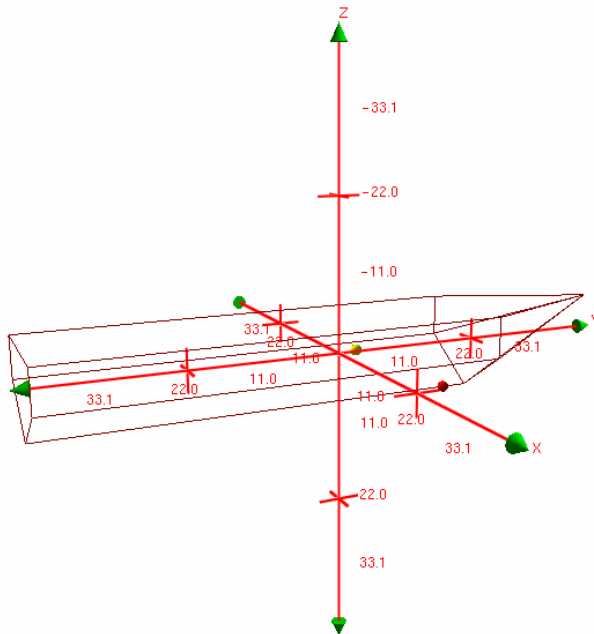

Fig. 5 Schema of locations of parts of the multibeam system. The red dot shows the location of the transducers (receive) and the yellow dot is the MRU. The navigation has been corrected to the MRU position and thus the offset is coincident with the MRU. The axes are placed on the approximate ship centre which is calculated from the values put in for length, beam and draught. These are not required in the calculations of multibeam bathymetry

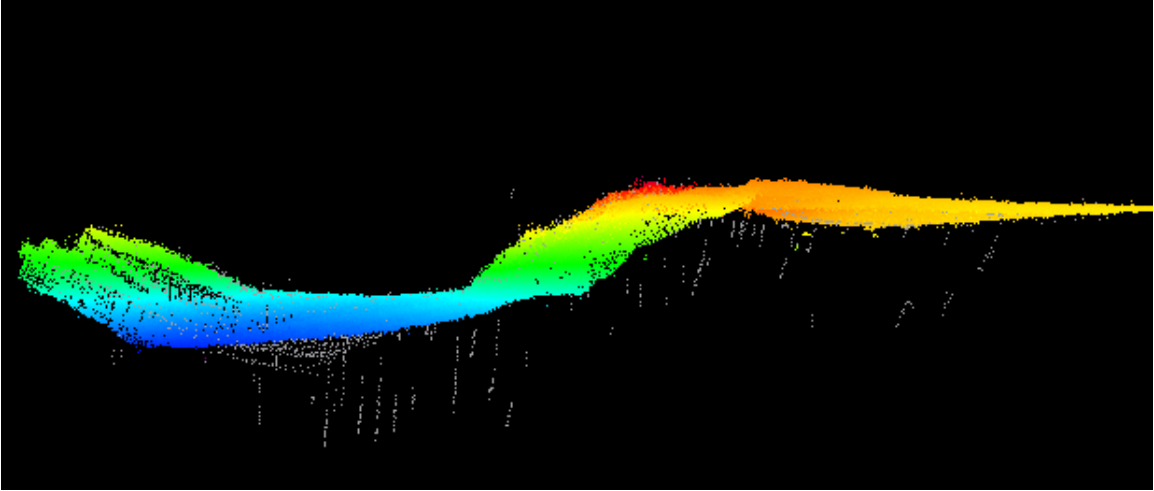

Fig. 6 Example of subset editor in CARIS HIPS. The model can be rotated in 3D and points picked. Grey points are bad data points edited out.

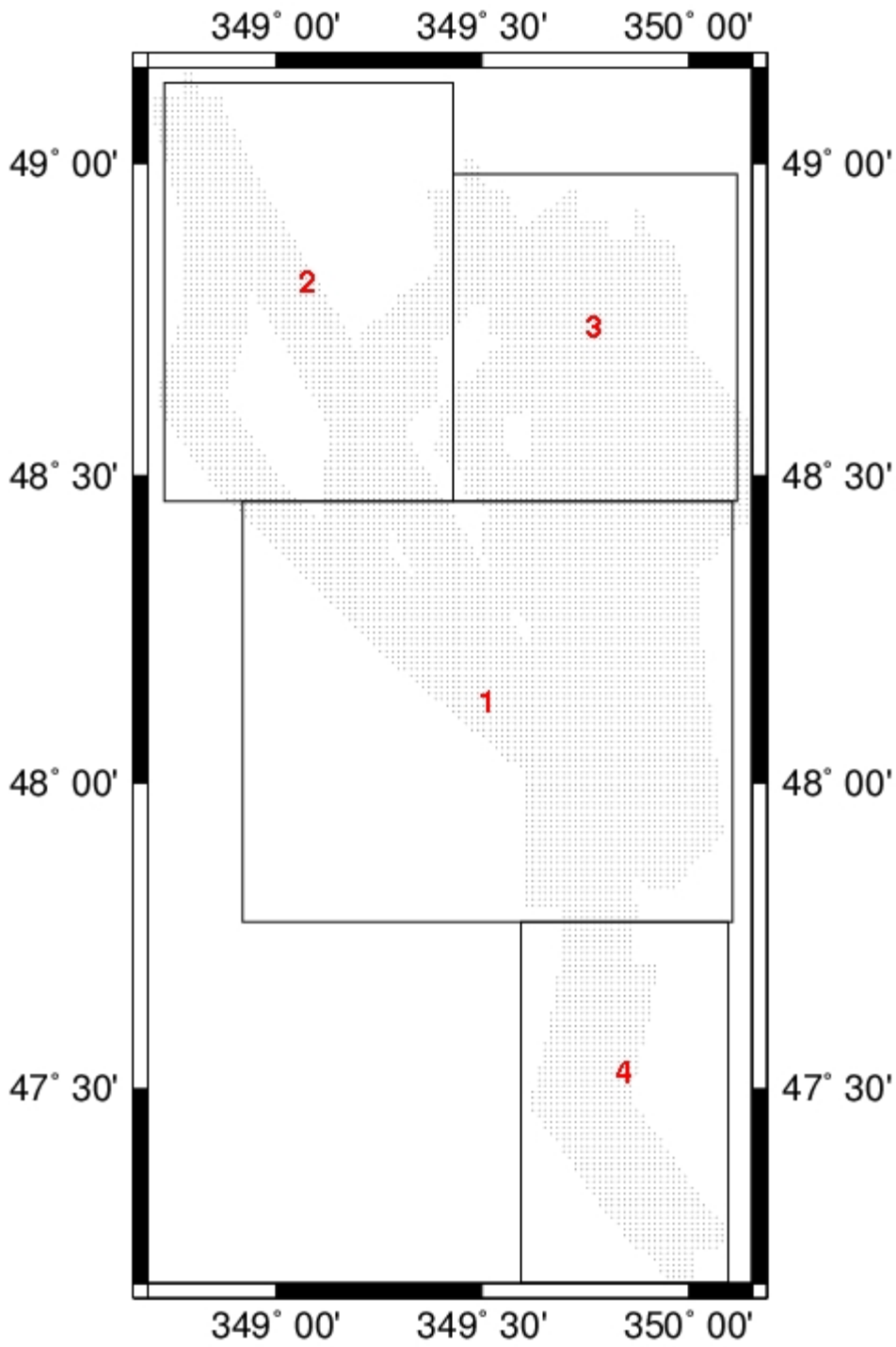

Fig. 7 Coverage of EM120 backscatter maps



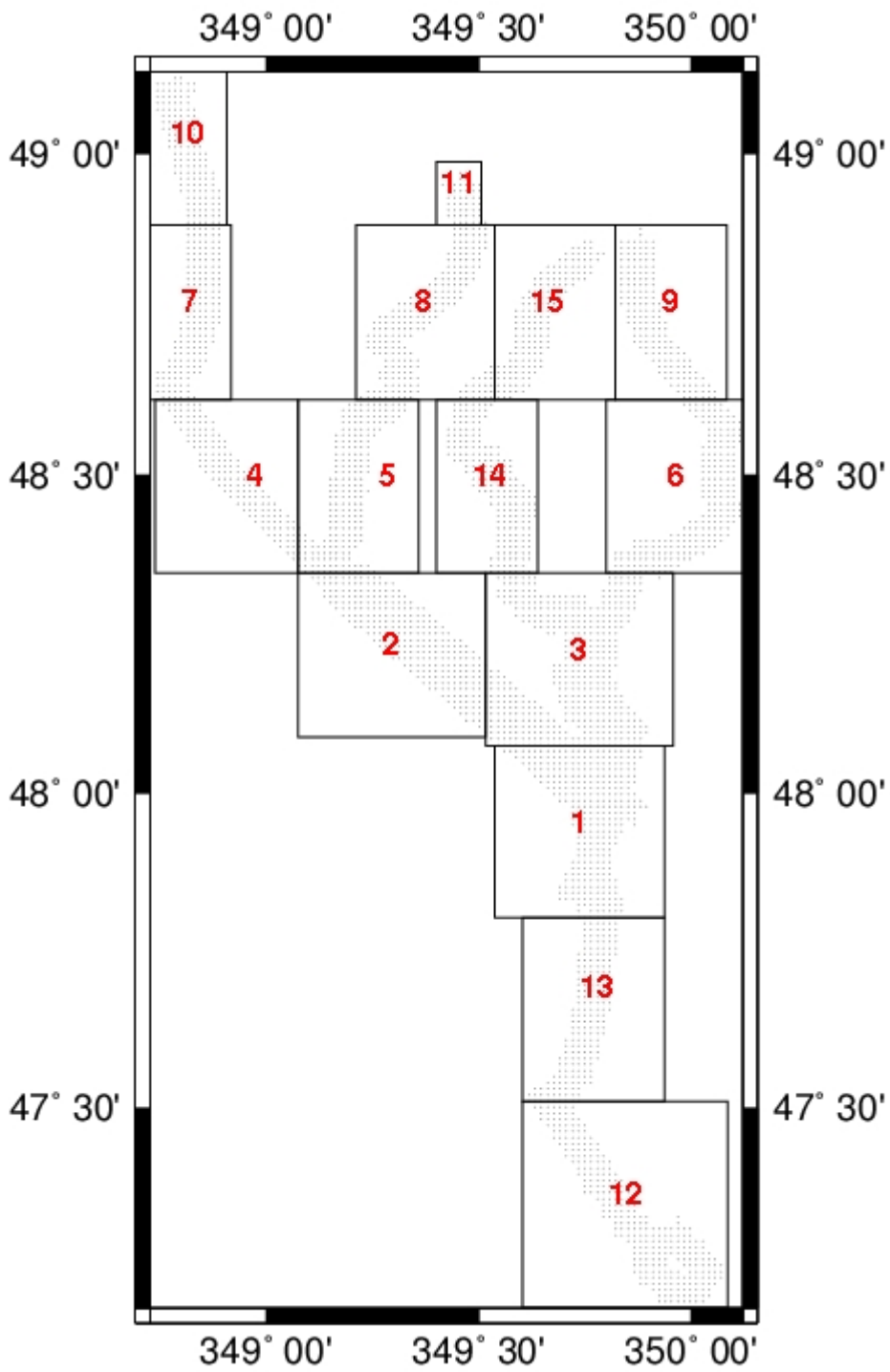

Fig. 8 Coverage of TOBI sidescan sonar tiles

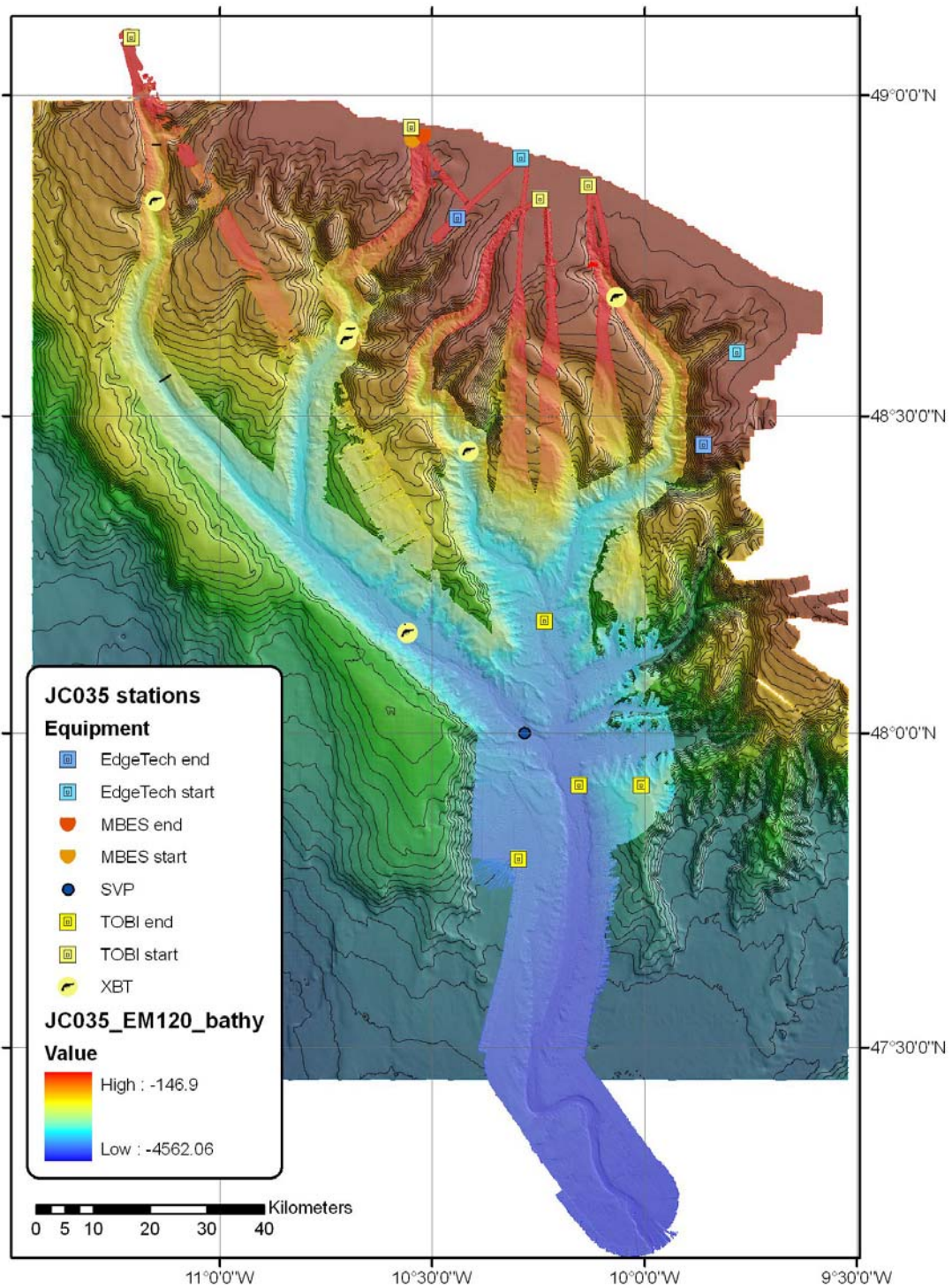

Fig. 9 Multibeam EM120 coverage obtained during JC035 (lighter colours, 50 m pixel size compared to 200 m in the underlying GSI bathymetry), with station locations

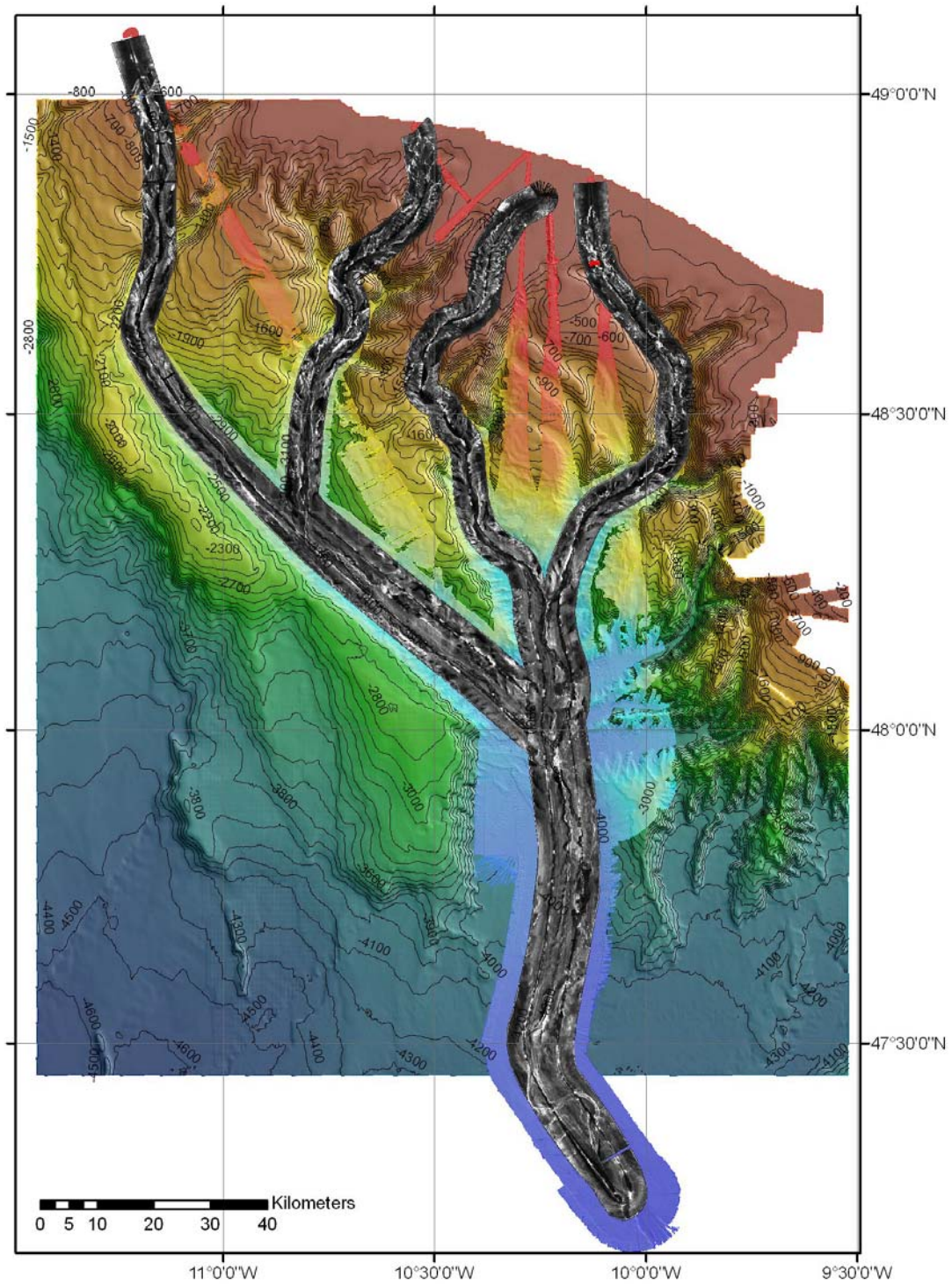

Fig. 10 TOBI coverage obtained during JC035